



Forward Phase Dimmer Installation Guide

Supported model

- C4-FPD120 Forward Phase Dimmer

Introduction

The Control4® Forward Phase Dimmer operates independently or as part of a Control4 home automation system. It installs in a standard wall box using typical wiring standards and communicates to the Control4 system using a wireless connection.

Box contents

- Forward Phase Dimmer
- Wire nuts
- Warranty card
- Forward Phase Dimmer Installation Guide* (this document)

Specifications and supported load types

The specifications are described below.

Model number	C4-FPD120-xx		
Power requirements	120 VAC +/-10%, 50/60 Hz This device can function with or without a neutral AC connection depending on load type. Wiring with a neutral is always the preferred wiring method (if possible). See load types and wiring diagrams below. When wired without a neutral, loads may appear dimmer.		
Power consumption	450mW		
Load types and ratings			
Supported load types	Incandescent, halogen, magnetic (iron core, inductive) low voltage (MLV) transformers, forward phase dimmable fluorescents, compact fluorescents, and LEDs.		
Maximum load	1 Gang	2 Gang	3+ Gang
Incandescent (tungsten)	1000W	800W	600W
Halogen	1000W	800W	600W
Fluorescent*	500W	500W	500W
Compact fluorescent (CFL)*	500W	500W	500W
LED*	200W	200W	200W
Minimum load (with neutral)			
Incandescent (tungsten)	4.5W		
Halogen	4.5W		
Fluorescent*	4.5W		
Compact fluorescent (CFL)*	4.5W		
LED*	4.5W		

Minimum load (without neutral)	
Incandescent (tungsten)	25W
Halogen	25W
Fluorescent*	N/A
Compact fluorescent (CFL)*	N/A
LED*	N/A
Environmental	
Operational temperature	32°F - 104°F (0°C - 40°C) All load ratings are based on an ambient temperature of 77°F (25°C).
Humidity	5% to 95% non-condensing
Storage	-4°F - 158°F (-20°C - 70°C)
Miscellaneous	
Control communications	ZigBee, IEEE 802.15.4, 2.4 GHz, 15-channel spread spectrum radio
Wallbox volume	5.75 cubic inches
Weight	0.12 lb. (0.05 kg)
Shipping weight	0.18 lb. (0.08 kg)



* NOTES:

- The maximum and minimum load requirements for fluorescent, CFL and LED loads can vary greatly depending upon the specific fixture and/or bulb being used. At higher wattages, these load types have significant in-rush current which can trip the protection circuitry on the device. At low wattages, some CFL and LED loads will not be able to completely shut off.
- In both cases, the quality and performance of these load types varies greatly from manufacturer to manufacturer. When using these load types, we recommend testing in advance. If problems are found, simply changing to a different bulb manufacturer may solve the problem.
- Additionally, we do not recommend the use of fluorescent, CFL, or LED loads without a neutral wire connected to the dimmer due to the capacitive nature of these load types.
- Wiring with a neutral is always the preferred wiring method (if possible).

Warnings and considerations



WARNING! Turn OFF electrical power before installing or servicing this product. Improper use or installation can cause SERIOUS INJURY, DEATH or LOSS/DAMAGE OF PROPERTY.

ATTENTION! Coupez l'alimentation électrique avant d'installer ou de réparer ce produit. Une mauvaise installation ou utilisation peut entraîner des blessures graves, décès ou perte / dommages à la propriété.



WARNING! This device must be protected by a circuit breaker (20A max). **ATTENTION!** Cet appareil doit être protégé par un disjoncteur (20A max.)



WARNING! Ground this device in accordance with the National Electric Code (NEC) requirements. DO NOT rely solely upon the yoke plate's contact with a metal wallbox for adequate grounding. Use the device's ground wire to make a secure connection to the safety ground of the electrical system.

ATTENTION! Cet appareil doit être en conformité avec le Code national de l'électricité (NEC). Ne comptez pas uniquement au contact de la plaque avant avec un boîtier mural métallique pour la mise à la terre adéquate. Utilisez cet appareil à la terre de l'appareil pour établir une connexion sécurisée au système électrique.



IMPORTANT! This device must be installed by a licensed electrician in accordance with all national and local electrical codes.



IMPORTANT! For wiring the dimmer, we recommend always using a neutral wire when possible. See Figure 6.



IMPORTANT! If you are unsure about any part of these instructions, consult a qualified electrician.



IMPORTANT! Use this device only with copper or copper-clad wire. Do not use aluminum wiring. This product has not been approved for use with aluminum wiring.



IMPORTANT! To reduce the risk of overheating and possible damage to other equipment, do not install to control a receptacle or a motor operated appliance.



IMPORTANT! This product generates heat during normal operation.



IMPORTANT! Using this product in a manner other than outlined in this document voids your warranty. Further, Control4 is NOT liable for any damage incurred with the misuse of this product. See "Troubleshooting."



IMPORTANT! Do NOT use a power screwdriver to install this device. If you do, you may overtighten the screws and strip them. Also, overtightening the screws may interfere with proper button operation.



IMPORTANT! This is an electronic device with intricate components. Handle and install with care!



IMPORTANT! When used in conjunction with an Auxiliary Keypad (C4-KA-xx), the wire connecting the Auxiliary Keypad to the dimmer must not exceed 150 feet (45 m) at 120VAC.

Installation instructions

- Ensure that the location and intended use meet the following criteria:
 - Do not exceed the load capacity requirements of the dimmer. In multi-gang installations, a reduction of the dimmers' capacity is required to allow the dimmers to be installed side-by-side. Refer to the load ratings in the specifications above for details.
 - Install in accordance with all national and local electrical codes.
 - The range and performance of the wireless control system is highly dependent on the following: (1) distance between devices; (2) layout of the home; (3) walls separating devices; and (4) electrical equipment located near devices.
- If installing in a multi-gang scenario, use pliers to remove the inner-side breakaway tabs. Bend each tab forward, and then back and forth until it breaks off. Remove the inner-side tabs ONLY on any device side that will be adjacent to another device. DO NOT remove tabs on any side that will become the outer side of a group of devices. Handle the device with care after removing the tabs, as the broken edge can be sharp.
- Turn off the local electrical power by either switching off the circuit breaker or removing the fuse from the fuse box. To ensure the wires do NOT have power running to them, use an inductive voltage detector.



NOTE: The wallbox wiring shown in this document is an example. Your wire colors and functions may differ. If you are not sure which wires are the Line In/Hot, Neutral, Load, Traveler, and Earth Ground wires, have a trained electrician perform the installation.



4 Prepare each wire. Wire insulation should be stripped back 5/8 of an inch from the wire end (see Figure 1).

Figure 1. Strip Wire Insulation

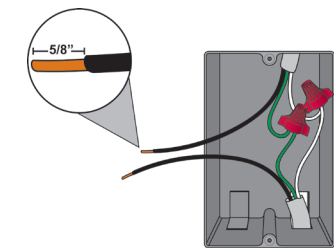

- Identify your wiring application, and then see the appropriate wiring diagram in the "Sample Wiring Configurations" section below.



IMPORTANT! Not grounding this product, as described in the "Warnings and Considerations" section, may result in an installation less immune to damage caused by electrical disturbances, such as ESD or lightning, and may void the warranty.



- Identify and connect the dimmer wires to the wallbox wires using the wire nuts.



IMPORTANT! The yellow wire is not a traditional traveler. It cannot directly power a lighting load. It must be used only to connect to a Control4 Auxiliary Keypad. See "Sample Wiring Configurations."



TIP: If you are using a Control4 push-on (screwless) faceplate in a multi-gang installation, attach the black faceplate sub-plate to all of the devices that will be installed into the wallbox prior to attaching the devices to the wallbox. This will help ensure that all the devices are properly aligned and on the same plane after installation.

- Fit the wires back into the wallbox. Bend the wires in a zigzag pattern so that they easily fold into the wallbox (Figure 2).

Figure 2. Bend the wires

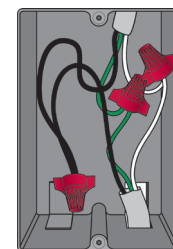

- Align the dimmer to the wallbox (the load rating label should be at the bottom) and fasten it with screws. Tighten the screws until the back side of the yoke plate is even with the wall surface, but no further. Overtightening can warp the dimmer and cause mechanical malfunction.
- Install the Control4 Faceplate following the instructions in the *Faceplate Installation Guide* or attach a standard Decora style faceplate.
- Turn ON power at the circuit breaker or replace the fuse from the fuse box.

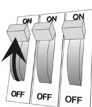

NOTE: If the dimmer flickers, adjust its max/min settings in Composer (e.g. min 15W, max 85W). See ctrl4.co/dimmersettings.

Operation and configuration

On initial power up, all status LEDs on the dimmer will illuminate green indicating that the device has power. To set up this dimmer for use with a Control4 system, refer to the *Composer Pro User Guide*.

To operate this dimmer as a stand-alone device:

- Click the **top button** to turn the light on.
- Click the **bottom button** to turn the light off.
- Press and hold the **top button** to ramp the light up. Release the button at the desired light level.
- Press and hold the **bottom button** to fade the light down. Release the button at the desired light level.

Air gap switch

During routine lamp replacement, you should remove power from the lamp by engaging the air gap mechanism. To engage, press on the right side of the top actuator bar until the left side pops out. All LEDs on the dimmer will turn off and the dimmer will no longer control the light when the air gap mechanism has been engaged. To return power to the dimmer and lamp, press on the left side of the top actuator bar until it snaps back into place.

Figure 3. Dimmer actuator bar

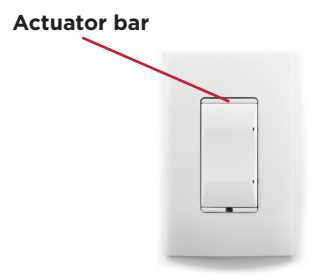

Button tap sequences

The button tap sequences are defined in the table below. Button tap sequences that require a single (1) button should use the top-most button installed on the dimmer.

Function	Button Sequence
Identify	4
ZigBee channel	7
Reboot	15
Factory reset	9-4-9
Leave mesh and reset	13-4-13

Troubleshooting

If the light does not turn on:

- Ensure at least one LED on the face of the dimmer is lit.
- Ensure the light bulb is not burned out and is screwed in tightly.
- Ensure that the circuit breaker is not turned OFF or tripped.
- Check for proper wiring (see "Sample Wiring Configurations").
- For help on the installation or operation of this product, email or call the Control4 Technical Support Center. Please provide your exact model number. Contact support@control4.com or see the web site www.control4.com.

Care and cleaning

- Do NOT paint the dimmer or its wall plate.
- Do NOT use any chemical cleaners to clean the dimmer.
- Clean surface of the dimmer with a soft damp cloth as needed.

Regulatory/Safety information

To review Regulatory information for your particular Control4 products, see the information located on the Control4 website at: <http://www.control4.com/regulatory/>.

Patent information

Applicable patents are available at <http://www.control4.com/legal/patents>.

Warranty

For complete warranty information, including details on consumer legal rights as well as warranty exclusions, review the Warranty card or visit www.control4.com/warranty.

Sample wiring configurations

Figure 4. Single device location, with neutral connection (recommended)

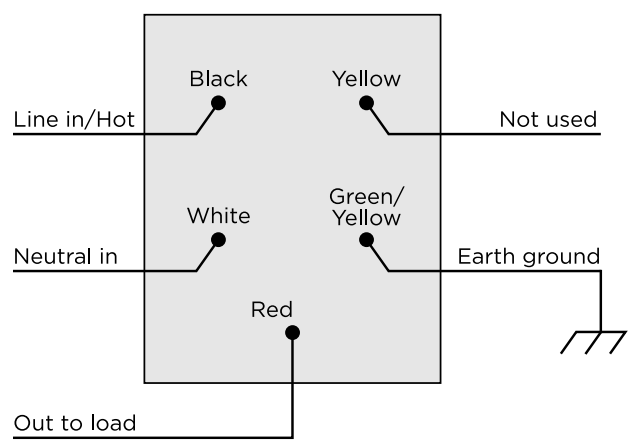

Figure 5. Single device location, without neutral connection

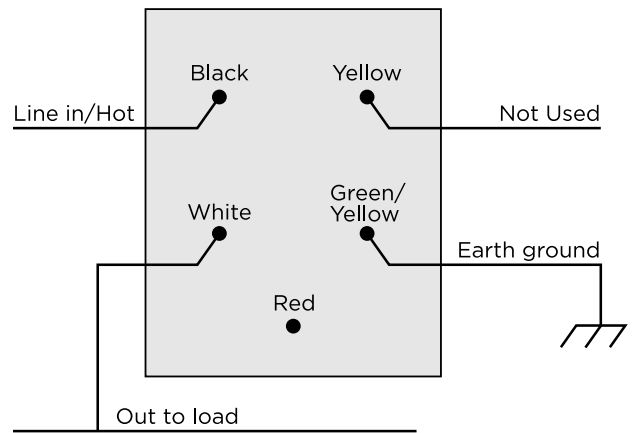

Figure 6. Multiple device location using Auxiliary Keypad, with neutral connection (recommended)

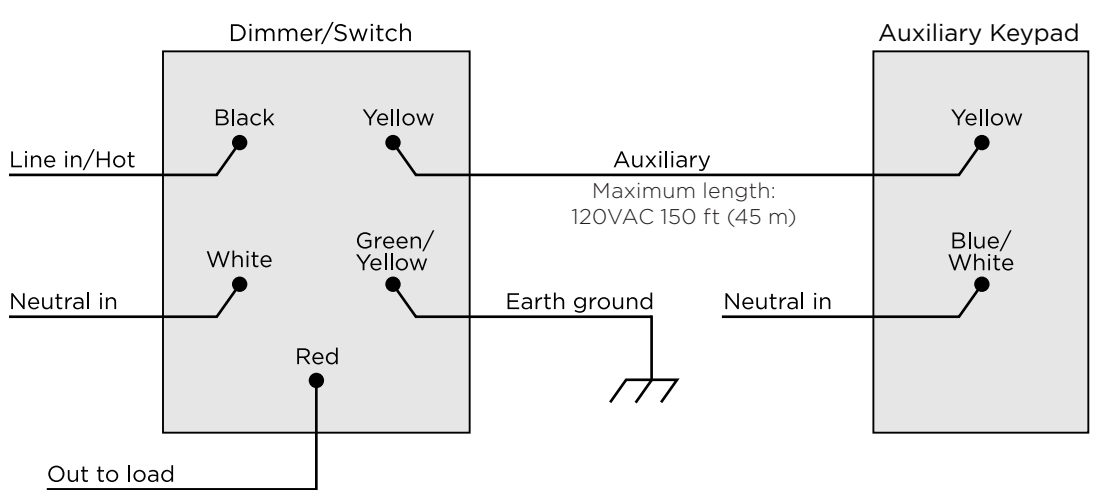
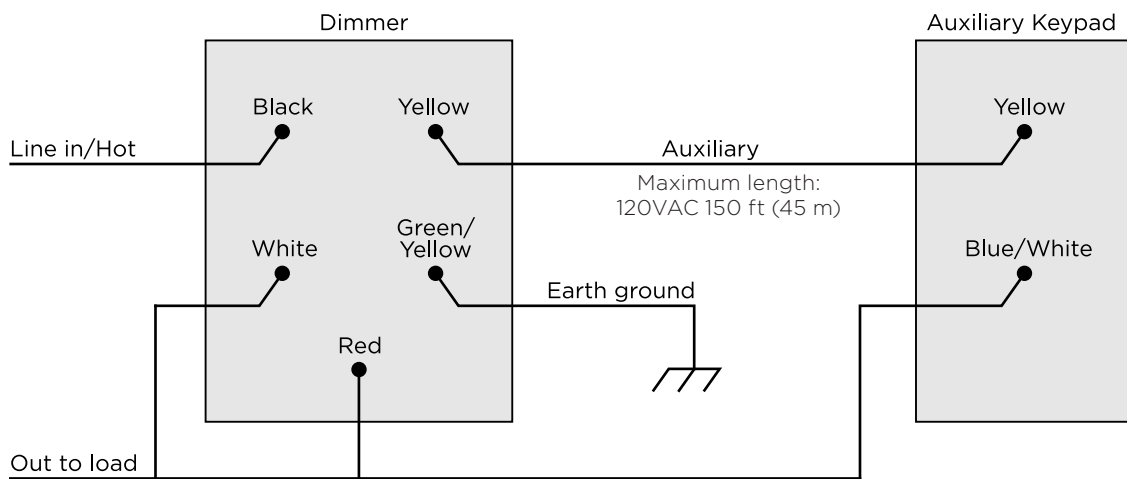

Figure 7. Multiple device location with Auxiliary Keypad, without neutral connection



IMPORTANT! When used in conjunction with an Auxiliary Keypad (C4-KA-xx), the wire connecting the Auxiliary Keypad to the dimmer must not exceed 150 feet (45 m) at 120VAC.

Figure 8. Multiple device location using Configurable Keypad, neutral required

