

# LX1200

**User Manual**

020-000430-01



# **CHRISTIE®**

---

## **LX1200**

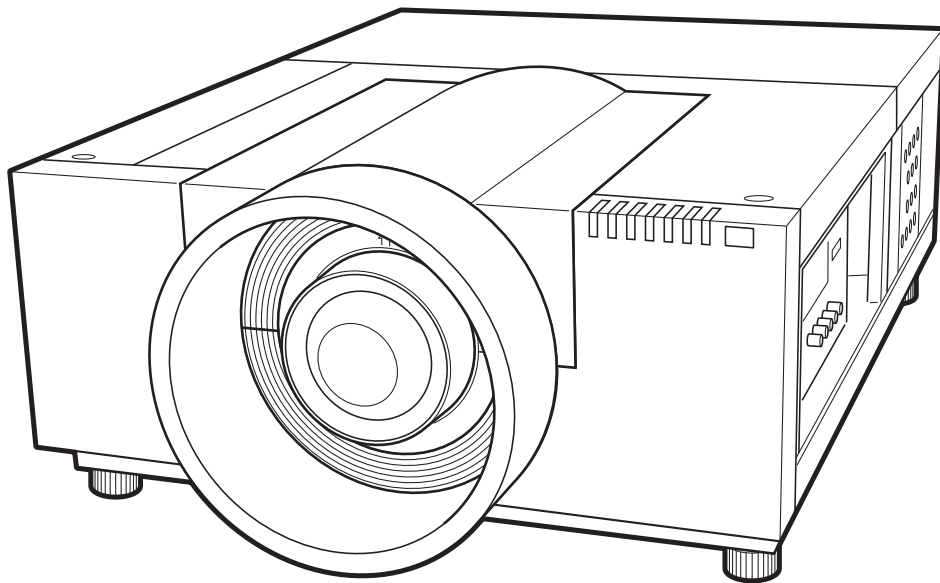

\* Lens not included.

## **User's Manual**

This Multimedia Projector is designed with most advanced technology for portability, durability, and ease of use. This projector utilizes built-in multimedia features, a palette of 1.07 billion colors, and matrix liquid crystal display (LCD) technology.

## ◆ **Functionally Rich**

This projector has many useful functions such as lens shifting, ceiling and rear projection, perpendicular omnidirectional projection, variety of lens options, etc.

## ◆ **Simple Computer System Setting**

The projector has the Multi-scan system to conform to almost all computer output signals quickly (p.34). Supported resolution up to WUXGA.

## ◆ **Useful Functions for Presentation**

Digital zoom function allows you to focus on the crucial information during a presentation (pp.29, 40).

## ◆ **Security Function**

The Security function helps you to ensure security of the projector. With the Key lock function, you can lock the operation on the side control or remote control (p.53). PIN code lock function prevents unauthorized use of the projector (pp.53–54).

## ◆ **Power Management**

The Power management function reduces power consumption and maintains lamp life (p.52).

## ◆ **Automatic Filter Replacement Function**

The projector monitors the condition of the filter and replaces a filter automatically when it detects the clogging.

## ◆ **Helpful Maintenance Functions**

Lamp and filter maintenance functions provide for better and proper maintenance of the projector.

## ◆ **New Optical Technology**

This projector is equipped with a new optical engine. The new optical engine controls the amount of yellow light in the image, producing higher brightness with improved color accuracy and clarity (p.46).

### ✓ **Note:**

- The On-Screen Menu and figures in this manual may differ slightly from the product.
- The contents of this manual are subject to change without notice.

## ◆ **Multilanguage Menu Display**

Operation menu is available in 12 languages; English, German, French, Italian, Spanish, Portuguese, Dutch, Swedish, Russian, Chinese, Korean, and Japanese (p.48).

## ◆ **Logo Function**

The Logo function allows you to customize the screen logo (pp.49–50). You can capture an image for the screen logo and use it for the starting-up display or between presentations.

## ◆ **Motor-driven Lens Shift**

Projection lens can be moved up, down, right and left with the motor-driven lens shift function. This function makes it easy to provide projected image where you want. Zoom and focus can also be adjusted with a motor-driven operation (p.27).

\*Zoom and focus functions may not operate depending on the optional lens.

## ◆ **Multi Versatile Platform**

This projector applies various input/output terminals and 2 terminal slots for expansion to tune to diversity of signals from computers and video equipment (p.19). For optional interface boards, contact sales dealer where you purchased the projector.

## ◆ **Shutter Function**

The projector is equipped with the shutter that provides complete blackness for a while the projected image is not needed with keeping the projector on. The Shutter management function allows you to set the timer. It prevents leaving the projector on with the shutter closed for a long time (p.55).

## ◆ **Network board (Optional)**

Network board is an optional product to control and set up the projector via the network cables with the web browser on your computer. It can be controlled and set up the projector remotely. Contact the sales dealer where you purchased this projector for optional parts.

|   |           |                                       |           |
|---|-----------|---------------------------------------|-----------|
| <b>Features and Design</b> . . . . .          | <b>2</b>  | Video Input Source Selection          | 33        |
| <b>Table of Contents</b> . . . . .            | <b>3</b>  | <b>Computer Input</b> . . . . .       | <b>34</b> |
| <b>To The Owner</b> . . . . .                 | <b>4</b>  | Computer System Selection             | 34        |
| <b>Safety Instructions</b> . . . . .          | <b>5</b>  | Auto PC Adjustment                    | 35        |
| Air Circulation                               | 6         | Manual PC Adjustment                  | 36        |
| Installing the Projector in Proper Directions | 7         | Image Level Selection                 | 38        |
| Moving the Projector                          | 8         | Screen Size Adjustment                | 39        |
| <b>Compliance</b> . . . . .                   | <b>9</b>  | <b>Video Input</b> . . . . .          | <b>41</b> |
| <b>Part Names and Functions</b> . . . . .     | <b>10</b> | Video System Selection                | 41        |
| Front   | 10        | Image Level Selection                 | 42        |
| Back  | 10        | Screen Size Adjustment                | 43        |
| Terminals and Connectors                      | 11        | <b>Picture Image</b> . . . . .        | <b>45</b> |
| Side Control and Indicators                   | 12        | Image Adjustment                      | 45        |
| Side Control                                  | 12        | <b>Setting</b> . . . . .              | <b>48</b> |
| Indicators                                    | 13        | Setting                               | 48        |
| Remote Control                                | 14        | <b>Maintenance and Care</b> . . . . . | <b>57</b> |
| Remote Control Battery Installation           | 15        | Filter Instructions                   | 57        |
| Remote Control Receivers and Operating Range  | 15        | Replacing the Filter Cartridge        | 58        |
| Wired Remote Control                          | 15        | Resetting the Filter Counter          | 59        |
| Remote Control Code                           | 16        | Resetting the Scroll Counter          | 59        |
| <b>Installation</b> . . . . .                 | <b>17</b> | Lamp Management                       | 60        |
| Lens Installation                             | 17        | Lamp Replacement                      | 61        |
| Installing the Strap for safety               | 17        | Resetting the Lamp Counter            | 62        |
| Positioning Projector                         | 18        | Cleaning the Projection Lens          | 64        |
| Lens Shift Adjustment                         | 18        | Cleaning the Projector Cabinet        | 64        |
| Picture Level and Pitch Adjustment            | 18        | Warning Indicators                    | 65        |
| Terminals of Projector                        | 19        | <b>Appendix</b> . . . . .             | <b>66</b> |
| Connecting to Computer                        | 20        | Troubleshooting                       | 66        |
| Connecting to Video Equipment                 | 21        | Menu Tree                             | 69        |
| Connecting the AC Power Cord                  | 22        | Indicators and Projector Condition    | 72        |
| <b>Basic Operation</b> . . . . .              | <b>23</b> | Compatible Computer Specifications    | 75        |
| Turning On the Projector                      | 23        | Technical Specifications              | 77        |
| Turning Off the Projector                     | 24        | Optional Parts                        | 78        |
| How to Operate the On-Screen Menu             | 25        | Configurations of Terminals           | 79        |
| Menu Bar                                      | 26        | PIN Code Number Memo                  | 80        |
| Operating with Projector Control              | 27        | Dimensions                            | 81        |
| Operating with Remote Control                 | 29        |                                       |           |
| <b>Input Selection</b> . . . . .              | <b>31</b> |                                       |           |
| Input   | 31        |                                       |           |
| Computer Input Source Selection               | 32        |                                       |           |

**Trademarks**

Each name of corporations or products in this book is either a registered trademark or a trademark of its respective corporation.

Before installing and operating the projector, read this manual thoroughly.

The projector provides many convenient features and functions. Operating the projector properly enables you to manage those features and maintains it in good condition for many years to come.

Improper operation may result in not only shortening the product life, but also malfunctions, fire hazard, or other accidents.

If your projector seems to operate improperly, read this manual again, check operations and cable connections and try the solutions in the "Troubleshooting" section in the back of this manual. If the problem still persists, contact the dealer where you purchased the projector or the service center.

|  |
|--|
| <div style="display: inline-block; text-align: center; background-color: black; color: white; padding: 5px; margin: 0 10px;"> <b>CAUTION</b><br/> <b>RISK OF ELECTRIC SHOCK</b><br/> <b>DO NOT OPEN</b> </div> |
| <b>CAUTION: TO REDUCE THE RISK OF ELECTRIC SHOCK, DO NOT REMOVE COVER (OR BACK). NO USER-SERVICEABLE PARTS INSIDE EXCEPT LAMP REPLACEMENT. REFER SERVICING TO QUALIFIED SERVICE PERSONNEL.</b>                 |
| THIS SYMBOL INDICATES THAT DANGEROUS VOLTAGE CONSTITUTING A RISK OF ELECTRIC SHOCK IS PRESENT WITHIN THIS UNIT.  |
| THIS SYMBOL INDICATES THAT THERE ARE IMPORTANT OPERATING AND MAINTENANCE INSTRUCTIONS IN THE USER'S MANUAL WITH THIS UNIT.   |

The symbol mark and recycling systems described below apply to EU countries and do not apply to countries in other areas of the world.

Your product is designed and manufactured with high quality materials and components which can be recycled and/or reused.

The symbol mark means that electrical and electronic equipment, batteries and accumulators, at their end-of-life, should be disposed of separately from your household waste.

Note:

If a chemical symbol is printed beneath the symbol mark, this chemical symbol means that the battery or accumulator contains a heavy metal at a certain concentration. This will be indicated as follows: Hg: mercury, Cd: cadmium, Pb: lead.

In the European Union there are separate collection systems for used electrical and electronic equipment, batteries and accumulators.

Please, dispose of them correctly at your local community waste collection/recycling centre.



Please, help us to conserve the environment we live in!

**READ AND KEEP THIS USER'S MANUAL FOR LATER USE.**



## Safety Precaution

**WARNING: ●THIS APPARATUS MUST BE EARTHED.**

**●TO REDUCE THE RISK OF FIRE OR ELECTRIC SHOCK, DO NOT EXPOSE THIS APPLIANCE TO RAIN OR MOISTURE.**

- This projector produces intense light from the projection lens. Do not stare directly into the lens, otherwise eye damage could result. Be especially careful that children do not stare directly into the beam.
- Install the projector in a proper position. Otherwise it may result in a fire hazard.
- Allowing the proper amount of space on the top, sides, and rear of the projector cabinet is critical for proper air circulation and cooling of the unit. The diagrams shown here indicates the minimum space required. If the projector is to be built into a compartment or similarly enclosed, these minimum distances must be maintained.
- Do not cover the ventilation slots on the projector. Heat build-up can reduce the service life of your projector, and can also be dangerous.

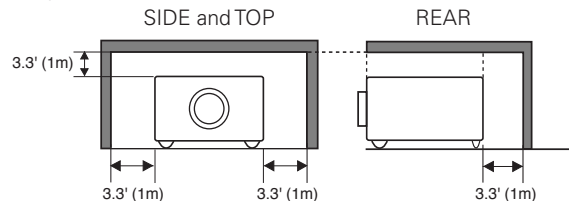

- If the projector is unused for an extended time, unplug the projector from the power outlet.
- Do not project the same image for a long time, since the afterimage may remain on the LCD panels by the characteristic of panel.



## CAUTION ON HANGING FROM THE CEILING

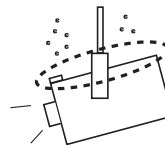

When hanging the projector from the ceiling, clean the air intake vents and top of the projector periodically with a vacuum cleaner. If you leave the projector unclean for a long time, the cooling fans can be clogged with dust, and it may cause a breakdown or a disaster.

**DO NOT SET THE PROJECTOR IN GREASY, WET, OR SMOKY CONDITIONS SUCH AS IN A KITCHEN TO PREVENT A BREAKDOWN OR A DISASTER. IF THE PROJECTOR COMES IN CONTACT WITH OIL OR CHEMICALS, IT MAY BECOME DETERIORATED.**

## CAUTION

Not for use in a computer room as defined in the Standard for the Protection of Electronic Computer/Data Processing Equipment, ANSI/NFPA 75.

All the safety and operating instructions should be read before the product is operated.

Read all of the instructions given here and retain them for later use. Unplug this projector from AC power supply before cleaning. Do not use liquid or aerosol cleaners. Use a damp cloth for cleaning.

Follow all warnings and instructions marked on the projector.

For added protection to the projector during a lightning storm, or when it is left unattended and unused for long periods of time, unplug it from the wall outlet. This will prevent damage due to lightning and power line surges.

Do not expose this unit to rain or use near water... for example, in a wet basement, near a swimming pool, etc...

Do not use attachments not recommended by the manufacturer as they may cause hazards.

Do not place this projector on an unstable cart, stand, or table. The projector may fall, causing serious injury to a child or adult, and serious damage to the projector. Use only with a cart or stand recommended by the manufacturer, or sold with the projector. Wall or shelf mounting should follow the manufacturer's instructions, and should use a mounting kit approved by the manufacturers.

An appliance and cart combination should be moved with care. Quick stops, excessive force, and uneven surfaces may cause the appliance and cart combination to overturn.



Slots and openings in the back and bottom of the cabinet are provided for ventilation, to ensure reliable operation of the equipment and to protect it from overheating.

The openings should never be covered with cloth or other materials, and the bottom opening should not be blocked by placing the projector on a bed, sofa, rug, or other similar surface. This projector should never be placed near or over a radiator or heat register.

This projector should not be placed in a built-in installation such as a book case unless proper ventilation is provided.

Never push objects of any kind into this projector through cabinet slots as they may touch dangerous voltage points or short out parts that could result in a fire or electric shock. Never spill liquid of any kind on the projector.

Do not install the projector near the ventilation duct of air-conditioning equipment.

This projector should be operated only from the type of power source indicated on the marking label. If you are not sure of the type of power supplied, consult your authorized dealer or local power company.

Do not overload wall outlets and extension cords as this can result in fire or electric shock. Do not allow anything to rest on the power cord. Do not locate this projector where the cord may be damaged by persons walking on it.

Do not attempt to service this projector yourself as opening or removing covers may expose you to dangerous voltage or other hazards. Refer all servicing to qualified service personnel.

Unplug this projector from wall outlet and refer servicing to qualified service personnel under the following conditions:

- a. When the power cord or plug is damaged or frayed.
- b. If liquid has been spilled into the projector.
- c. If the projector has been exposed to rain or water.
- d. If the projector does not operate normally by following the operating instructions. Adjust only those controls that are covered by the operating instructions as improper adjustment of other controls may result in damage and will often require extensive work by a qualified technician to restore the projector to normal operation.
- e. If the projector has been dropped or the cabinet has been damaged.
- f. When the projector exhibits a distinct change in performance-this indicates a need for service.

When replacement parts are required, be sure the service technician has used replacement parts specified by the manufacturer that have the same characteristics as the original part. Unauthorized substitutions may result in fire, electric shock, or injury to persons.

Upon completion of any service or repairs to this projector, ask the service technician to perform routine safety checks to determine that the projector is in safe operating condition.

**NOTE FOR CUSTOMERS IN THE US**

Ⓜ LAMP(S) INSIDE THIS PRODUCT CONTAIN MERCURY AND MUST BE RECYCLED OR DISPOSED OF ACCORDING TO LOCAL, STATE OR FEDERAL LAWS.

**Air Circulation**

Openings in the cabinet are provided for ventilation. To ensure reliable operation of the product and to protect it from overheating, these openings must not be blocked or covered.

**CAUTION**

Hot air is exhausted from the exhaust vent. When using or installing the projector, the following precautions should be taken.

- Do not put any flammable object or spray can near the projector, hot air is exhausted from the air vents.
- Keep the exhaust vent at least 3' (1 m) away from any objects.
- Do not touch peripheral parts of the exhaust vent, especially screws and metallic parts. These areas will become hot while the projector is being used.
- Do not put anything on the cabinet. Objects put on the cabinet will not only get damaged but also may cause fire hazard by heat.
- Do not cover vents with papers or other materials.
- Make sure that there are no objects under the projector. An object under the projector may prevent the projector from taking cooling air through bottom vent.

Cooling fans are provided to cool down the projector. The fans' running speed is changed according to the temperature inside the projector.

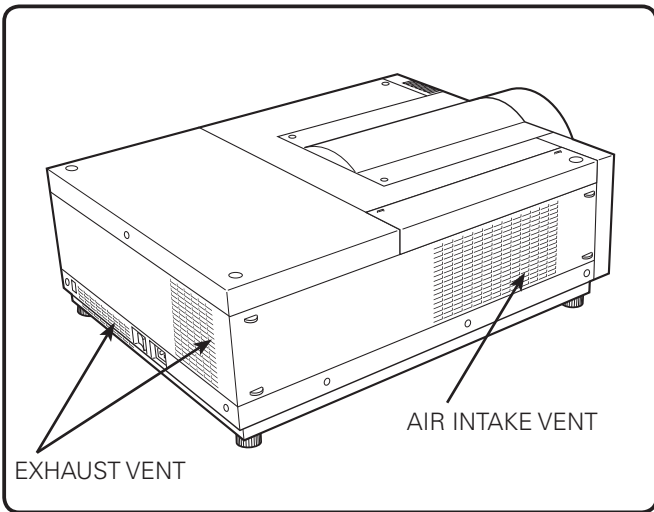

**IMPORTANT!**  
**Filter Maintenance!!**

The projector uses a lamp which generates significant heat. The cooling fans and air vents are provided to dissipate the heat by drawing air into the housing and the filter is located in the intake vents to prevent dust from getting inside of the projector.

In order to care for the projector appropriately, regular cleaning is required. Remove any dirt or dust that has accumulated on the projector.

If the projector reaches a time set in the timer setting, a Filter replacement icon (Fig. 1) appears on the screen and WARNING FILTER indicator on the top panel lights up (see below), indicating that the filter replacement is necessary.

If the projector detects that the filter is clogged and no scroll is left in the filter cartridge, a Filter cartridge replacement icon (Fig. 2) appears on the screen and WARNING FILTER indicator on the top panel lights up (see below). Stop using the projector immediately and replace the filter cartridge.

Blocking the air vents and leaving the projector uncleaned for a long time may not only damage the projector and may require costly repairs but may also cause accidents or fire.

For maintenance of the filter, refer to "Filter counter" on page 56 and "Maintenance and Care" on pages 57-59.

**Damages to the projector caused by using an uncleaned filter or improper maintenance will void the warranty on the projector.**

**Top Panel**

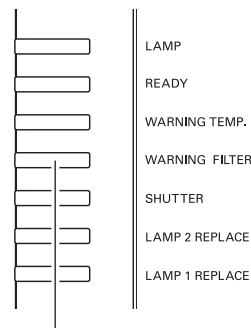

**Fig.1** Filter replacement icon



**Fig.2** Filter cartridge replacement icon

**WARNING FILTER indicator**



### **Installing the Projector in Proper Directions**

Use the projector properly in specified positions. Improper positioning may reduce the lamp life and result in severe accident or fire hazard.

This projector can project the picture in upward, downward, or inclined position in perpendicular direction to the horizontal plane.

**✓ Note:**

- To inverse or reverse the image, set the ceiling function to "On." (pp. 40, 44)
- The projector can not be operated at an altitude above 3,000 meters.

### **Positioning Precautions**

Avoid positioning the projector as described below when installing.

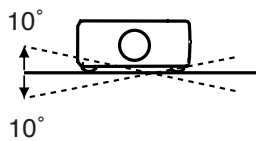

Do not roll the projector more than 10 degrees from side to side.

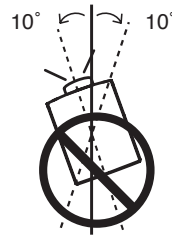

In upward projection, do not tilt the projector over 10 degrees right and left.



Do not put the projector on either side to project an image.

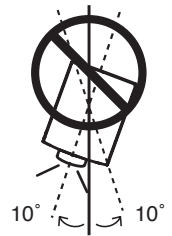

In downward projection, do not tilt the projector over 10 degrees right and left.



### **CAUTION ON CEILING MOUNTING**

For ceiling mounting, you need the ceiling mount kit designed for this projector. When not mounted properly, the projector may fall, causing hazards or injury. For details, consult your dealer. The warranty on this projector does not cover any damage caused by use of any non-recommended ceiling mount kit or installation of the ceiling mount kit in an improper location.

## Moving the Projector



Retract the adjustable feet to prevent damage to lens and cabinet. For safety, holding the projector on both sides by 2 or more people is recommended to move the projector because the projector is heavy. When moving the projector by one person from necessity, hold the handle carefully. Do not hold the lens mount cover. Moving it improperly may result in damage of cabinet or person's injury.

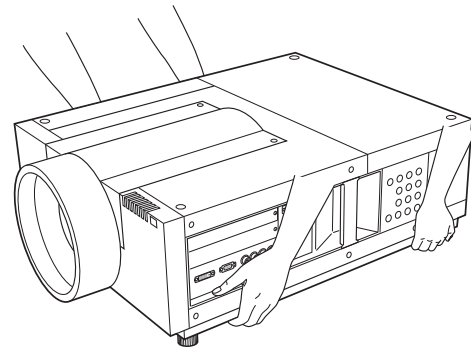

### CAUTION IN CARRYING OR TRANSPORTING THE PROJECTOR

- Do not drop or bump the projector, otherwise damages or malfunctions may result.
- When carrying the projector, use a suitable carrying case.
- Do not transport the projector by courier or any other transport service in an unsuitable transport case. This may cause damage to the projector. For information about transporting the projector by courier or any other transport service, consult your dealer.
- Do not put the projector in a case before it is cooled enough.
- Do not transport the projector with a replacement lens installed.

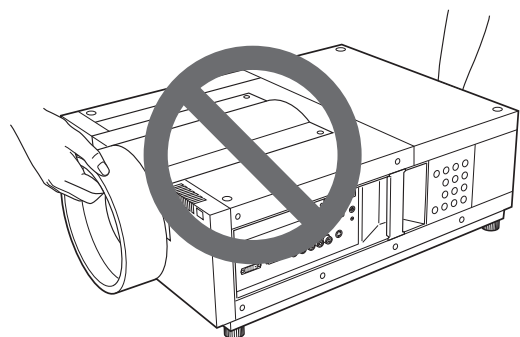
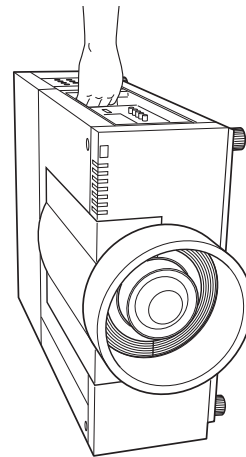

## Federal Communications Commission Notice

This equipment has been tested and found to comply with the limits for a Class A digital device, pursuant to Part 15 of FCC Rules. These limits are designed to provide reasonable protection against harmful interference when the equipment is operated in a commercial environment. This equipment generates, uses, and can radiate radio frequency energy and, if not installed and used in accordance with the instruction manual, may cause harmful interference to radio communications. Operation of this equipment in a residential area is likely to cause harmful interference in which case the user will be required to correct the interference at his own expense.

Do not make any changes or modifications to the equipment unless otherwise specified in the instructions. If such changes or modifications should be made, you could be required to stop operation of the equipment.

## Canadian Radio Interference Regulations

This Class A digital apparatus meets all requirements of the Canadian ICES-003.

## WARNING

This is a Class A product. In a domestic environment this product may cause radio interference in which case the user may be required to take adequate measures.

## AC Power Cord Requirement

The AC Power Cord supplied with this projector meets the requirement for use in the country you purchased it.

### AC Power Cord for the United States and Canada:

AC Power Cord used in the United States and Canada is listed by the Underwriters Laboratories (UL) and certified by the Canadian Standard Association (CSA).

AC Power Cord has a grounding-type AC line plug. This is a safety feature to be sure that the plug will fit into the power outlet. Do not try to defeat this safety feature. Should you be unable to insert the plug into the outlet, contact your electrician.

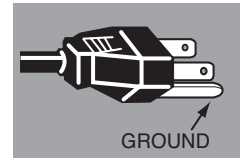

**THE SOCKET-OUTLET SHOULD BE INSTALLED NEAR THE EQUIPMENT AND EASILY ACCESSIBLE.**

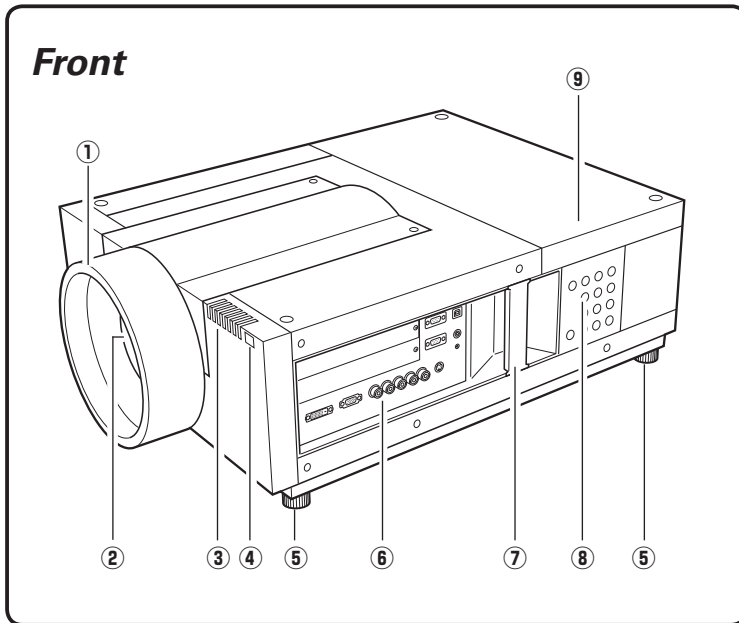

- ① Lens Mount Cover
- ② Projection Lens (Option)
- ③ Indicators
- ④ Infrared Remote Receiver (Front)
- ⑤ Adjustable Feet
- ⑥ Terminals and Connectors
- ⑦ Handle
- ⑧ Side Control
- ⑨ Lamp Cover

- ⑩ Infrared Remote Receiver (Rear)
- ⑪ Exhaust Vent

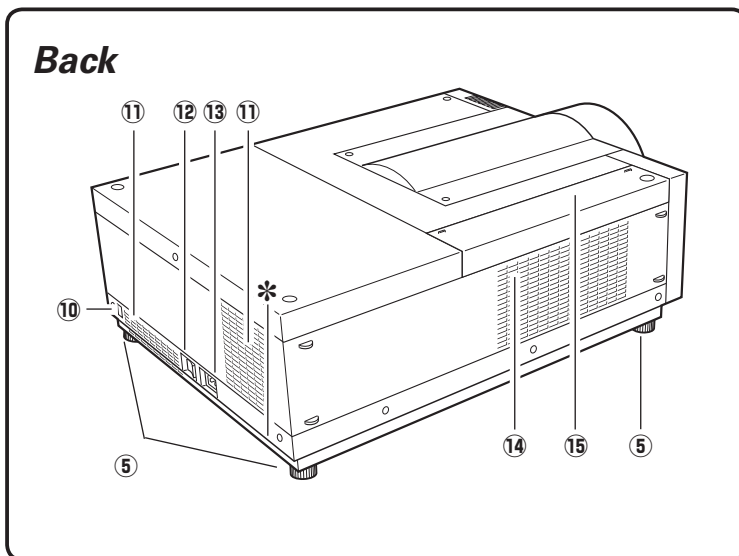

- ⑫ Main On/Off Switch
- ⑬ Power Cord Connector
- ⑭ Air Intake Vent
- ⑮ Air Filter Cover



**CAUTION**

Hot air is exhausted from the exhaust vent. Do not put heat-sensitive objects near this side.

**\*Kensington Security Slot**

This slot is for a Kensington lock used to deter theft of the projector.

\*Kensington is a registered trademark of ACCO Brands Corporation.

Terminals and Connectors

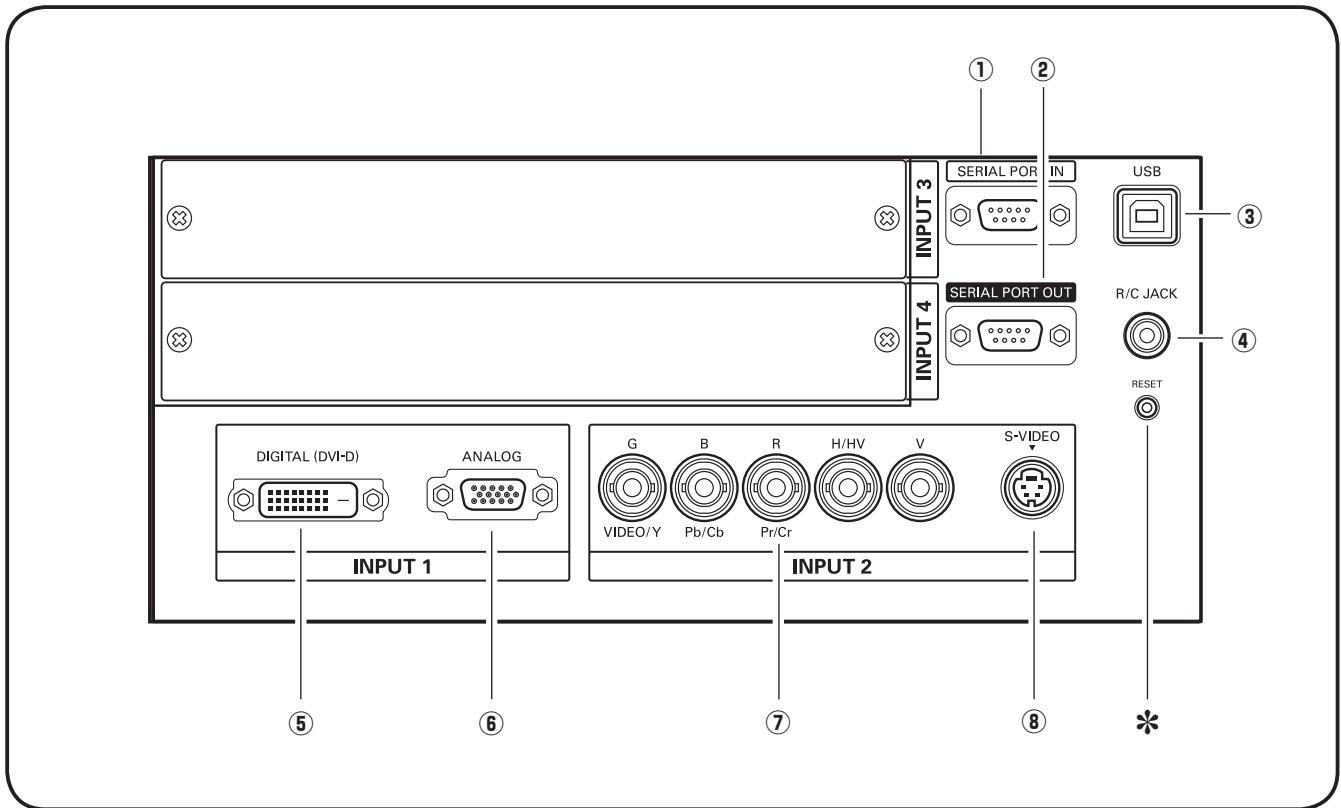

① SERIAL PORT IN TERMINAL

If you control the projector by computer, you must connect a cable (not supplied) from your computer to this terminal.

② SERIAL PORT OUT TERMINAL

This terminal outputs signal from SERIAL PORT IN. More than two projectors can be controlled with one computer by connecting SERIAL PORT IN of another projector to this terminal.

③ USB CONNECTOR (Series B)

USB connector is to used to service the projector.

④ R/C JACK

When using the wired remote control, connect the wired remote control to this jack with a remote control cable (not supplied).

\* RESET button

A built-in micro processor which controls this unit may occasionally malfunction and need to be reset. This can be done by pressing the RESET button with a pen, which will shut down and restart the unit. Do not use the RESET function excessively.

⑤ DVI INPUT TERMINAL

Connect computer output (Digital/DVI-D type) to this terminal (p.20). HD (HDCP Compatible) signal can be also connected (p.21).

⑥ D-sub 15-PIN INPUT TERMINAL

Connect computer output (Analog D-sub 15-pin type) to this terminal (pp.20–21).

⑦ 5 BNC INPUT JACKS

Connect the component or composite video output signal from video equipment to VIDEO/Y, Pb/Cb, and Pr/Cr jacks or connect the computer output signal (5 BNC Type [Green, Blue, Red, Horiz. Sync, and Vert. Sync.]) to G, B, R, H/V, and V jacks (pp.20–21).

⑧ S-VIDEO INPUT JACK

Connect the S-VIDEO output signal from video equipment to this jack (p.21).

**Side Control and Indicators**

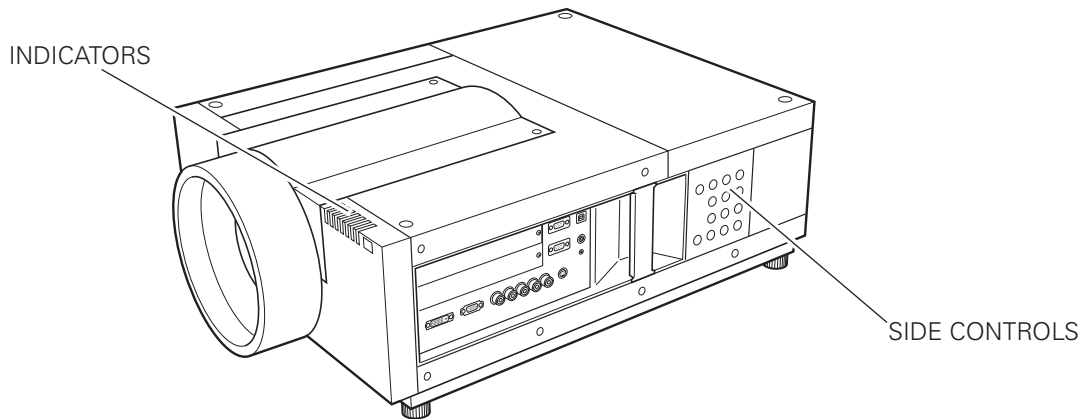

**Side Control**

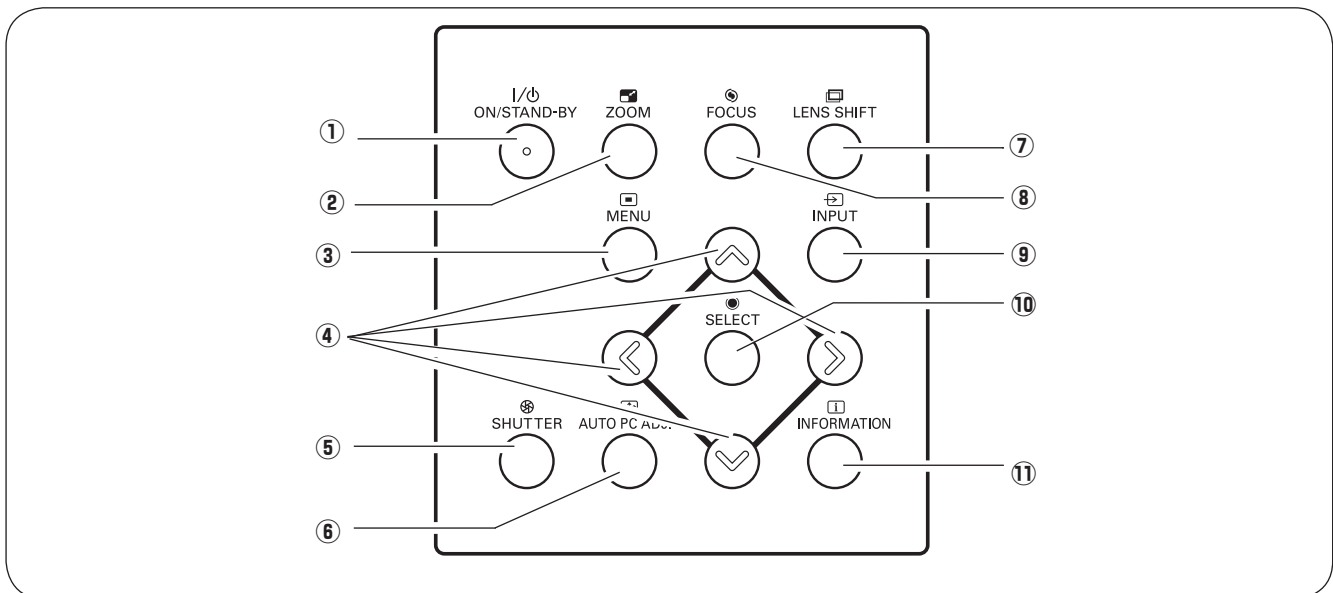

- |  |  |
|--|--|
| <p>① <b>ON/STAND-BY button</b><br/>Turn the projector on or off (pp.23,24).</p> <p>② <b>ZOOM button</b><br/>Zoom in and out the images (p.27).</p> <p>③ <b>MENU button</b><br/>Open or close the On-Screen MENU (pp.25, 26).</p> <p>④ <b>POINT buttons</b><br/>- Select an item or adjust the value in the On-Screen MENU (p.25).<br/>- Pan the image in DIGITAL ZOOM + mode (p.40).</p> <p>⑤ <b>SHUTTER button</b><br/>Close and open up the built-in shutter (p.27).</p> <p>⑥ <b>AUTO PC ADJ. button</b><br/>Automatically adjust the computer image to its optimum setting (pp.27, 35).</p> | <p>⑦ <b>LENS SHIFT button</b><br/>Select the LENS SHIFT function (p.27).</p> <p>⑧ <b>FOCUS button</b><br/>Adjust the focus (p.27).</p> <p>⑨ <b>INPUT button</b><br/>Select an input source Input 1, Input 2, Input 3 or Input 4 (pp.31-33).</p> <p>⑩ <b>SELECT button</b><br/>Used to execute the selected item (p.25). It is also used to expand or compress the image in DIGITAL ZOOM mode (p.40).</p> <p>⑪ <b>INFORMATION button</b><br/>Display the input source information (p.28).</p> |
|--|--|

**Indicators**

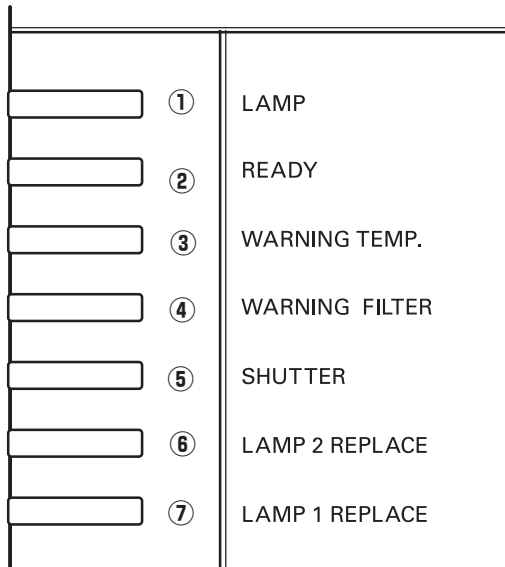

**① LAMP Indicator**  
 This indicator is dim when the projector is turned on. And bright when the projector is in stand-by mode (pp.72-74).

**② READY indicator**  
 This indicator lights green when the projector is ready to be turned on. And it flashes green in Power Management mode (pp.52, 72-74).

**③ WARNING TEMP. indicator**  
 This indicator flashes red when internal projector temperature is too high (pp.65, 72-74).

**④ WARNING FILTER indicator**  
 -Blink slow when the filter is being scrolled (pp. 57, 72).  
 -Blink fast when the filter scroll is not working properly or the filter cartridge is not installed (pp.57, 74).  
 -Light orange when the clogging of the filter is detected or the filter counter reaches a time set in the timer setting, urging immediate filter/ filter cartridge replacement (pp.56, 57, 74).

**⑤ SHUTTER indicator**  
 Light blue when the shutter is closed (p72).

**⑥ LAMP 2 REPLACE indicator**  
 Turn orange when the life of the projection lamp2 draws to an end (pp.61, 73).

**⑦ LAMP 1 REPLACE indicator**  
 Turn orange when the life of the projection lamp1 draws to an end (p.61, 73).

## Remote Control

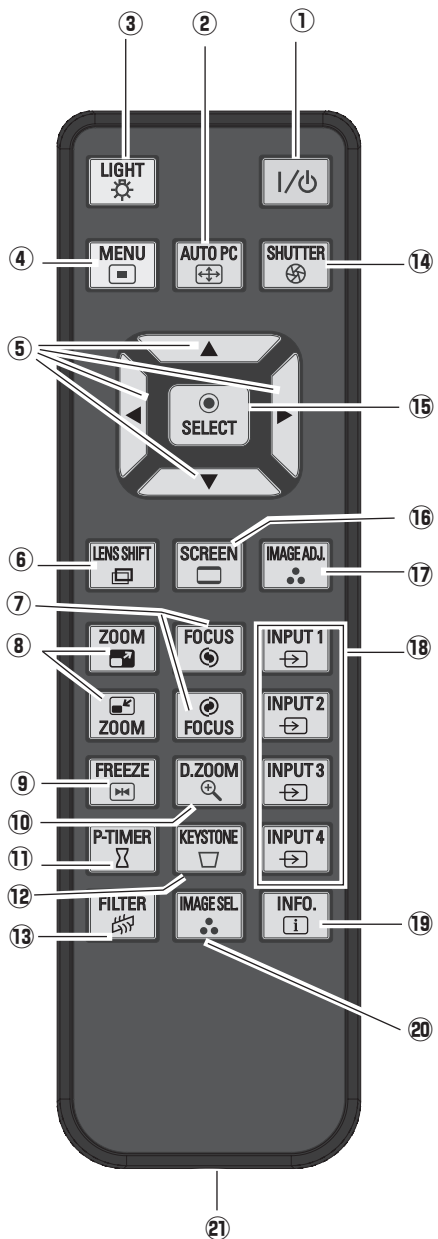

## ✓ Note:

To ensure safe operation, observe the following precautions:

- Do not bend, drop, or expose the remote control to moisture or heat.
- For cleaning, use a soft dry cloth. Do not apply benzene, thinner, spray, or any other chemical materials.

- ① **ON/STAND-BY button**  
Turn the projector on or off (pp.23-24).
- ② **AUTO PC button**  
Automatically adjust the computer image to its optimum setting (pp.29, 35).
- ③ **LIGHT button**  
Light the buttons on the remote control for about 10 seconds.
- ④ **MENU button**  
Open or close the On-Screen MENU (pp.25-26).
- ⑤ **POINT ▲▼◀▶ buttons**  
–Select an item or adjust the value in The ON-SCREEN MENU (p.25).  
–Pan the image in DIGITAL ZOOM + mode (p.40).
- ⑥ **LENS SHIFT button**  
Select the LENS SHIFT function (p.29).
- ⑦ **FOCUS buttons**  
Adjust the focus (p.29).
- ⑧ **ZOOM buttons**  
Zoom in and out the images (p.29).
- ⑨ **FREEZE button**  
Freeze the picture on the screen (p.29).
- ⑩ **D.ZOOM button**  
Select the Digital zoom +/- mode and resize the image (pp.29, 40).
- ⑪ **P-TIMER button**  
Operate the P-TIMER function (p.30).
- ⑫ **KEystone button**  
Correct keystone distortion (pp.30, 40, 44).
- ⑬ **FILTER button**  
Scroll the filter (p.30).
- ⑭ **SHUTTER button**  
Close the built-in shutter for light blocking (pp.27, 30).
- ⑮ **SELECT button**  
–Execute the selected item (p.25).  
–Expand or compress the image in the DIGITAL ZOOM mode (p.40).
- ⑯ **SCREEN button**  
Select the screen size (pp.39-40).
- ⑰ **IMAGE ADJ. button**  
Enter the image level adjustment mode (pp.30, 45-47).
- ⑱ **INPUT 1, 2, 3, 4 buttons**  
Select an input source (pp.31-33).
- ⑲ **INFO. button**  
Display the input source information (p.29).
- ⑳ **IMAGE SEL. button**  
Select the image level (pp.30, 38, 42).
- ㉑ **Wired Remote Jack**  
Connect the remote control cable (not supplied) to this jack when using as a wired remote control.



## Remote Control Battery Installation

**1** Open the battery compartment lid.

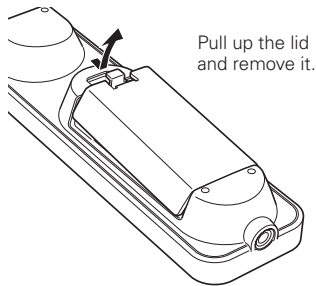

**2** Install new batteries into the compartment.

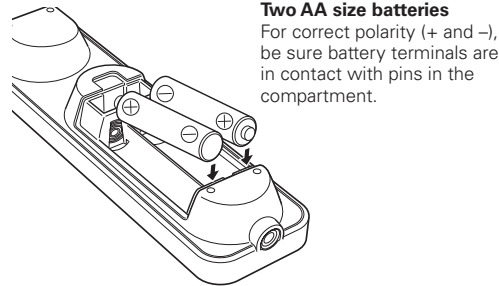

**3** Replace the compartment lid.

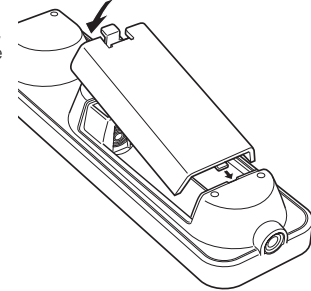

To ensure safe operation, please observe the following precautions :

- Use two (2) AA or LR6 type alkaline batteries.
- Always replace batteries in sets.
- Do not use a new battery with a used battery.
- Avoid contact with water or liquid.
- Do not expose the remote control to moisture or heat.
- Do not drop the remote control.
- If the battery has leaked on the remote control, carefully wipe the case clean and install new batteries.
- Risk of an explosion if battery is replaced by an incorrect type.
- Dispose of used batteries according to the instructions.

## Remote Control Receivers and Operating Range

Point the remote control toward the projector (to Infrared Remote Receivers) when pressing the buttons. Maximum operating range for the remote control is about 16.4' (5 m) and 60 degrees in front and rear of the projector.

Infrared Remote Receivers are provided both in front and back of the projector. You can conveniently use both of the receivers (pp. 10, 52).

**✓Note:**

- When hanging the projector from the ceiling, select the Infrared Remote Receiver which is located farther away from the fluorescent light (p.52).

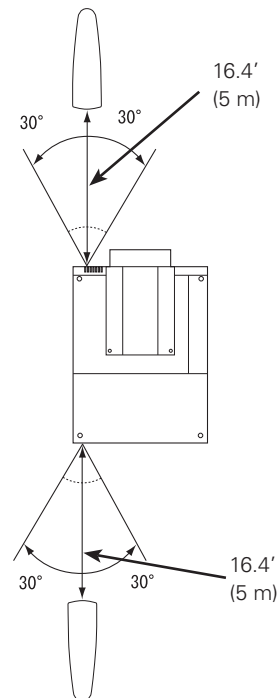

## Wired Remote Control

The remote control can be used as a wired remote control. Wired remote control helps you use the remote control outside of the operating range (16.4' / 5 m). Connect the remote control and the projector with the remote control cable (sold separately). Connected with the remote control cable, the remote control does not emit wireless signal.

### Remote Control Code

The eight different remote control codes (Code 1–Code 8) are assigned to this projector. Switching the remote control codes prevents interference from other remote controls when several projectors or video equipment next to each other are operated at the same time. Change the remote control code for the projector first before changing that for the remote control. See “Remote control” in the Setting Menu on page 52.

- 1 Flip the Reset Switch to "Use position" in the compartment lid on the back of the remote control.
- 2 While holding down the MENU button, press and release the IMAGE ADJ. button the number of corresponding times you would like to set the number of the remote control code for the projector.

| Remote Control Code | Number of Times Pressing IMAGE ADJ. button |
|---------------------|--|
| Code 1              | 1  |
| Code 2              | 2  |
| Code 3              | 3  |
| Code 4              | 4  |
| Code 5              | 5  |
| Code 6              | 6  |
| Code 7              | 7  |
| Code 8              | 8  |

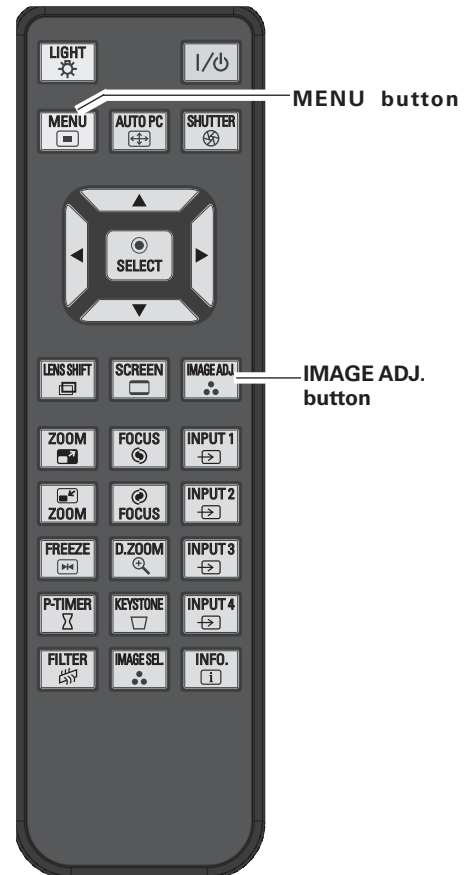
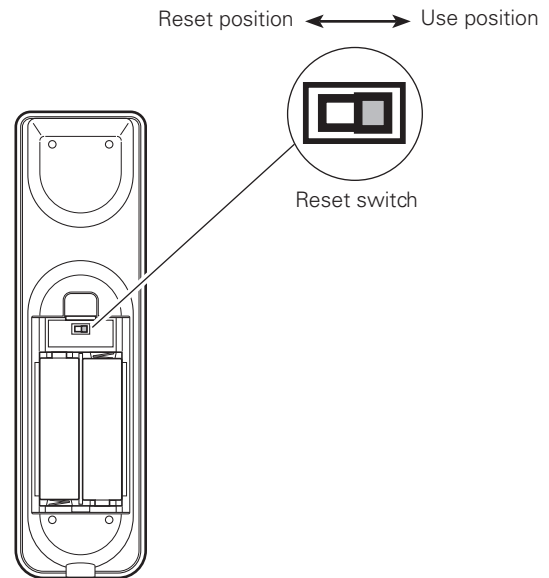

## Lens Installation

Before setting up the projector, install Projection Lens on the projector.

Before installation, check where the projector is used and prepare a suitable lens. For the specifications of Projection Lens, contact sales dealer where you purchased the projector.



- **Do not use the optional lens below for this projector. Otherwise damages may result.**

**LENS MODEL NO. : 38-809041-02**

- **Lens installation and replacement should be made by the qualified service personnel.**

- When setting the projector after lens installation, be sure to replace a Lens Cap to protect a surface.

- When carrying or holding up the projector, be careful not to put your hands on lens part. It may damage lens, cabinet, or mechanical parts.

## Installing the Strap for safety

Secure the lens mount cover and the projector with the strap (supplied) to prevent the lens mount cover from falling down.

- 1** Turn the lens mount cover counter-clockwise and take it off by pulling forward. (See Fig. 1)
- 2** Remove the screw **A**. (See Fig. 1)
- 3** Put the strap through the hole of the lens mount cover and fasten it firmly. (See Fig. 2)

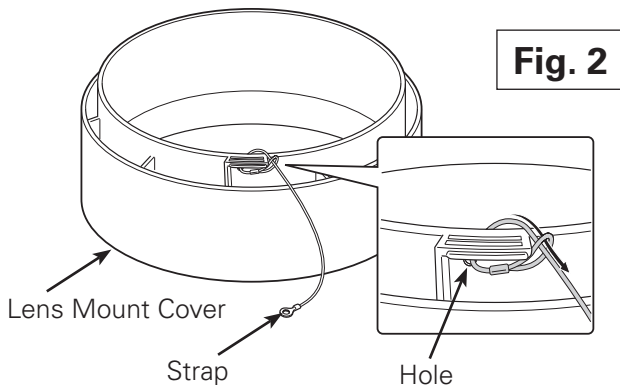
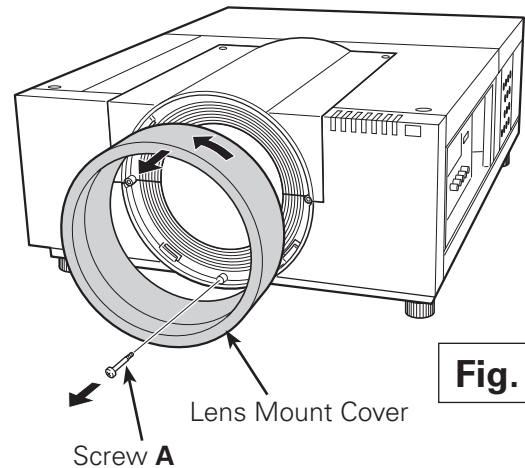

**Fig. 2**

- 4** Install the other end of the strap to the front of the projector with screw **A**. (See Fig. 3)
- 5** Fit the raised dot of the lens mount cover to the leftmost edge of the Label on the projector, and then turn the lens mount cover clockwise and adjust the position of the raised dot to the one of the projector until it makes a clicking sound. (See Fig. 3)

**✓Note:**

- The accessory screw (supplied) is not used for installation.



**Fig. 1**

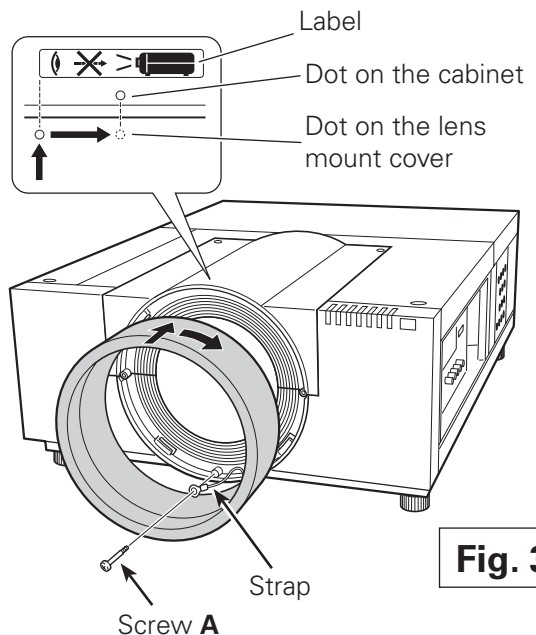

**Fig. 3**

### Positioning Projector

This projector is designed to project on a flat projection surface.

**✓Note:**

- *Brightness in room has a great influence on picture quality. It is recommended to limit ambient lighting in order to provide the best image.*

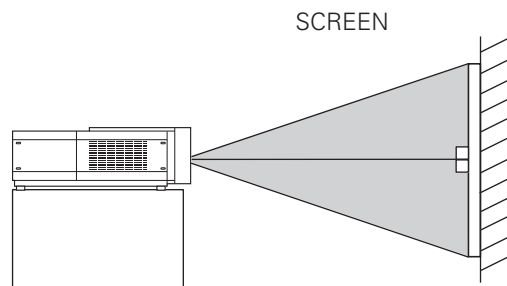

### Lens Shift Adjustment

Projection lens can be moved from side to side and up and down with the motor-driven lens shift function. This function makes the positioning of images easy on the screen. (See page 27)

The display position can be shifted upward up to 50% elevation of the display.

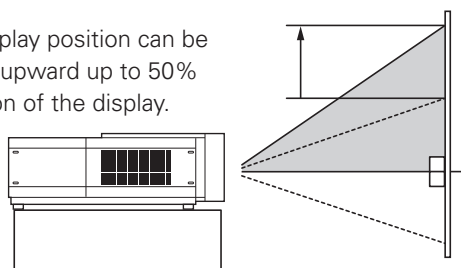

**When the lens is shifted to top.**

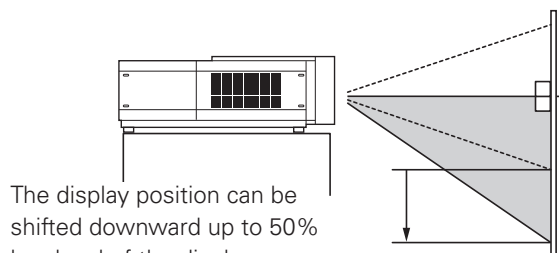

The display position can be shifted downward up to 50% low level of the display.

**When the lens is shifted to bottom.**

The display position can be shifted to the left in up to 10% width of the display.

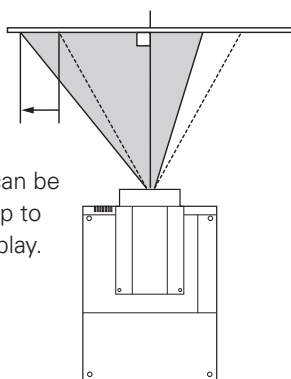

**When the lens is shifted to leftmost.**

The display position can be shifted to the right in up to 10% width of the display.

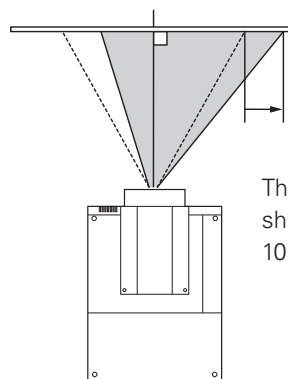

**When the lens is shifted to rightmost.**

### Picture Level and Pitch Adjustment

The projection angle is adjustable up to 2.8 degrees upward and downward respectively by rotating front and back feet .

To raise the projector, rotate the feet clockwise.

To lower the projector or to retract the adjustable feet, rotate the feet counterclockwise.

To correct keystone distortion, press the KEYSTONE button on the remote control or select Keystone from the menu (see pages 14, 30, 40, 44).



Do not rotate the adjustable feet when you see the red line on the adjustable feet. The adjustable feet may fall off.

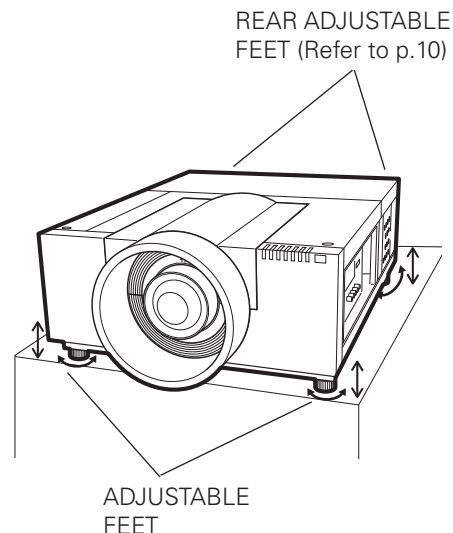

## Terminals of Projector

The projector has two replaceable Interface board slots. The projector's functions can be extended by installing the optional interface boards into the terminal slots. 2 vacant slots (Input 3 and 4) are provided in your purchasing the projector. For the Optional Interface Boards, contact sales dealer where you purchased the projector.

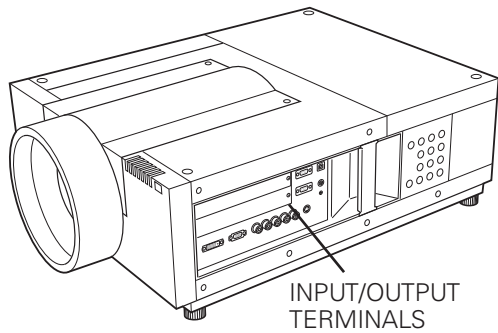

2 TERMINAL SLOTS (Factory set)

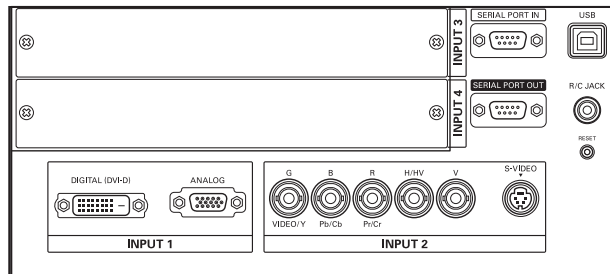

DVI / D-sub 15 Terminal    5-BNC / VideoTerminal

## Replacement of Terminal

✓ **Note:**

- In the replacement of interface board, turn off the projector, press the Main On/Off Switch to Off and unplug the AC power cord from the AC outlet.

- 1** Remove 2 Screws from an interface board.
- 2** Pull out the interface board.
- 3** Replace the interface board. Insert a new interface board along Guide to fit Socket to inside Plug.
- 4** Tighten screws to secure the interface board.

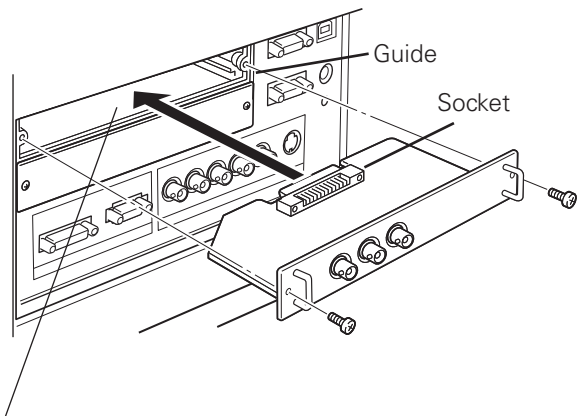
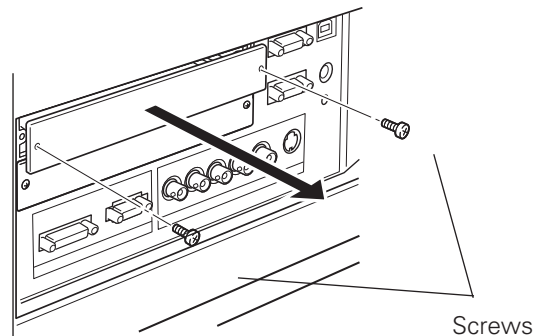

Plug

Figure shows Dual-SDI terminal.

## NOTES ON ORDERING OR USING OPTIONAL INTERFACE BOARD

When ordering or using Optional Interface Board, contact your sales dealer. When contacting the sales dealer, tell the Option Control Number (Op.cont.No.) in the menu that is located on the bottom of the information menu. (See page 28)

## Connecting to Computer

### Cables used for connection

- VGA Cable (D-sub 15 pin) \*
  - DVI Cable
  - BNC Cable (BNC x 5)
- (\*One cable is supplied; Other cables are not supplied with this projector.)

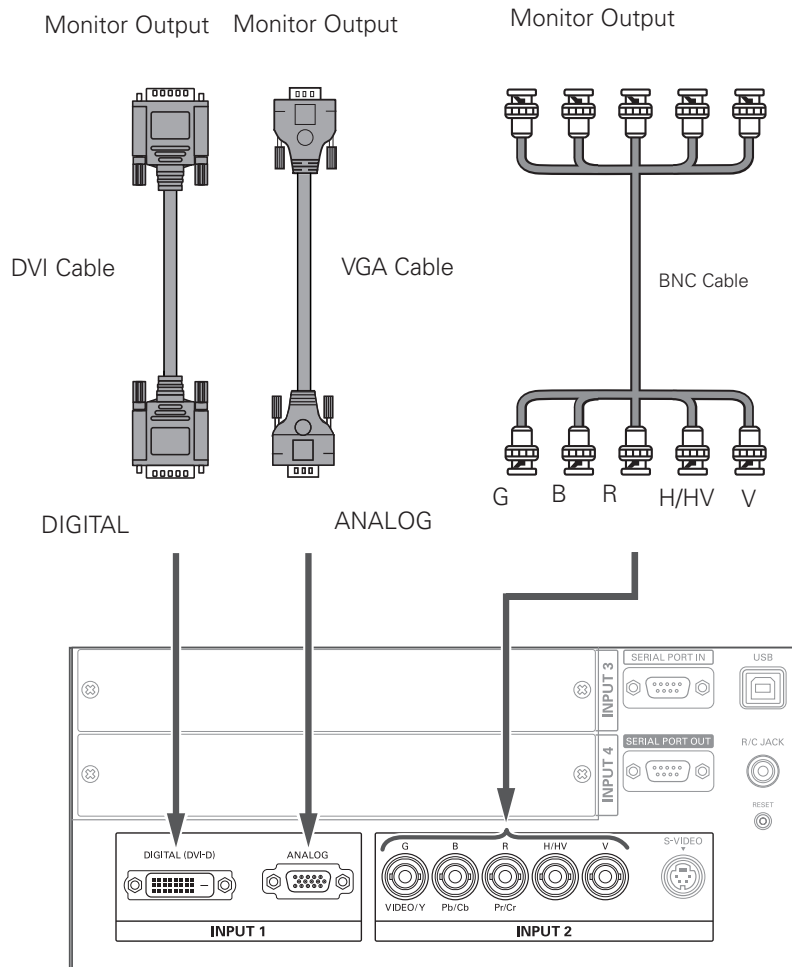
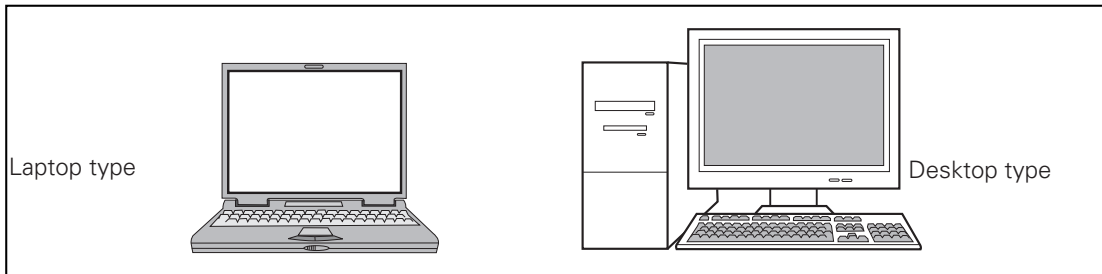

Unplug the power cords of both the projector and external equipment from the AC outlet before connecting cables.

## Connecting to Video Equipment

### Cables used for connection

- Video Cable (BNC x 3, BNC x 1)
  - SCART-VGA Cable
  - DVI Cable
  - S-Video Cable
- (Cables are not supplied with the projector.)

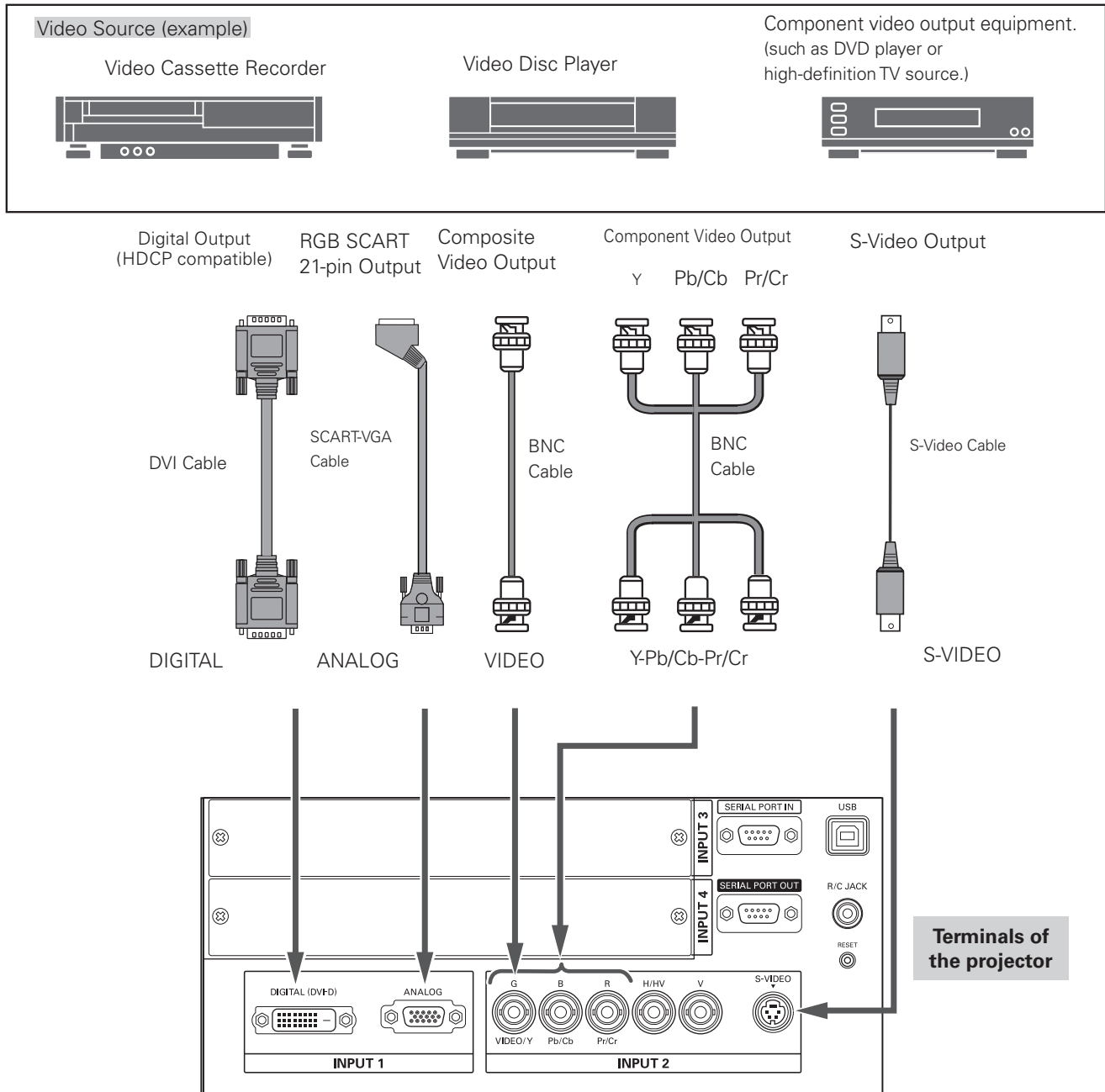

Unplug the power cords of both the projector and external equipment from the AC outlet before connecting cables.

### Connecting the AC Power Cord

This projector uses nominal input voltages of 100-120 or 200-240 V AC. It is designed to work with single-phase power systems having a grounded neutral conductor. To reduce the risk of electrical shock, do not plug into any other type of power system. If you are not sure of the type of power being supplied, consult your authorized dealer or service center. Connect the projector with all peripheral equipment before turning on the projector.



**CAUTION**

The AC outlet must be near this equipment and must be easily accessible.

✓ **Note:**

- Unplug the AC power cord or turn off the MAIN ON/OFF Switch when the projector is not in use. When the projector is in stand-by mode, it consumes a little electric power.

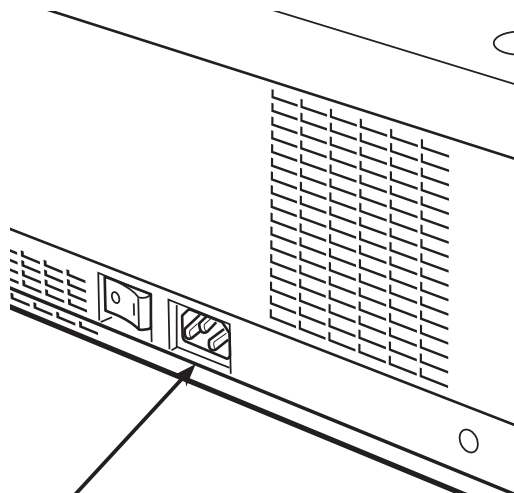

Connect the AC power cord (supplied) to the projector.

**NOTE ON THE POWER CORD**

AC power cord must meet the requirements of the country where you use the projector. Confirm the AC plug type with the chart below and proper AC power cord must be used. If the supplied AC power cord does not match your AC outlet, contact your sales dealer.

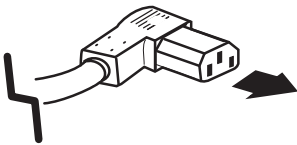
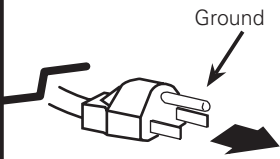
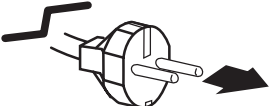
| Projector side  | AC Outlet side   |  |
|---|--|--|
|  <p>To POWER CORD CONNECTOR on your projector.</p> | <p><b>For the U.S.A. and Canada</b></p>  <p>Ground</p> <p>To the AC Outlet.<br/><b>(120 V AC)</b></p> | <p><b>For Continental Europe</b></p>  <p>To the AC Outlet.<br/><b>(200-240 V AC)</b></p> |



## Turning On the Projector

- 1** Complete peripheral connections (with a computer, VCR, etc.) before turning on the projector.
- 2** Connect the projector's AC power cord into an AC outlet and turn on the MAIN ON/OFF Switch. The LAMP indicator lights red and the READY indicator lights green.
- 3** Press the ON/STAND-BY button on the side control or on the remote control. The LAMP indicator dims red and the cooling fans start to operate. The preparation display appears on the screen and the countdown starts.
- 4** After the countdown, the input source that was selected the last time and the Lamp mode icon (see page 60) appear on the screen.

If the projector is locked with a PIN code, PIN code Input Dialog Box will appear. Enter the PIN code as instructed below.

### Enter a PIN code

Use the Point ▲▼ buttons on the side control or on the remote control to enter a number. Press the Point ► button to fix the number and move the red frame pointer to the next box. The number changes to “\*.” Repeat this step to complete entering a four-digit number. After entering the four-digit number, move the pointer to “Set.” Press the SELECT button so that you can start to operate the projector.

If you fixed an incorrect number, use the Point ◀ button to move the pointer to the number you want to correct, and then enter the correct number.

If you entered an incorrect PIN code, “PIN code” and the number (\*\*\*\*) will turn red for a moment. Enter the correct PIN code all over again.

### What is PIN code?

PIN (Personal Identification Number) code is a security code that allows the person who knows it to operate the projector. Setting a PIN code prevents unauthorized use of the projector.

A PIN code consists of a four-digit number. Refer to the PIN code lock function in the Setting Menu on page 53-54 for locking operation of the projector with your PIN code.



The preparation display will disappear after 20 seconds.

### Selected Input Source and Lamp control

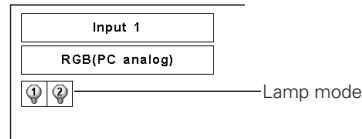

See page 60 for the Lamp mode status

### ✓ Note:

- The Lamp replacement icon and the Filter warning icon may appear on the screen depending on the usage state of the projector.

### PIN code Input Dialog Box

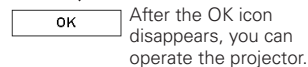
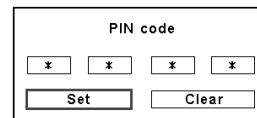

### ✓ Note:

- When the Logo select function is set to “Off,” the logo will not be shown on the screen (p.49).
- When the “Countdown off” or “Off” is selected in the Display function, the countdown will not be shown on the screen (p.48).
- During the countdown period, all operations are invalid.
- If the PIN code number is not entered within three minutes after the PIN code dialog box appeared, the projector will be turned off automatically.
- The “1234” is set as the initial PIN code at the factory.



### CAUTION ON HANDLING PIN CODE

If you forget your PIN code, the projector can no longer be started. Take special care in setting a new PIN code; write down the number in a column on page 80 of this manual and keep it on hand. Should the PIN code be missing or forgotten, consult your dealer or service center.

## Turning Off the Projector

- 1** Press the ON/STAND-BY button on the side control or on the remote control, and "Power off?" appears on the screen.
- 2** Press the ON/STAND-BY button on the side control or on the remote control again to turn off the projector. The LAMP indicator lights bright and the READY indicator turns off. After the projector is turned off, the cooling fans operate. You cannot turn on the projector during this cooling down period.
- 3** When the projector has cooled down enough, the READY indicator lights green and then you can turn on the projector. To turn off the MAIN ON/OFF Switch, wait until the projector is completely cooled down.
- 4** Unplug the AC power cord from the AC outlet.

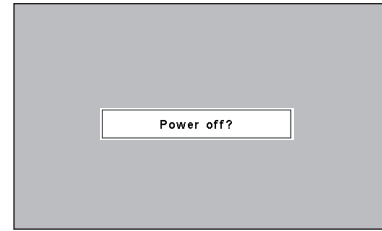

"Power off?" disappears after 4 seconds.



TO MAINTAIN THE LIFE OF THE LAMP, ONCE YOU TURN THE PROJECTOR ON, WAIT AT LEAST FIVE MINUTES BEFORE TURNING IT OFF. DO NOT UNPLUG THE AC POWER CORD WHILE COOLING FANS ARE RUNNING OR BEFORE THE READY INDICATOR LIGHTS GREEN AGAIN. OTHERWISE IT WILL RESULT IN SHORTENING OF THE LAMP LIFE.



DO NOT OPERATE THE PROJECTOR CONTINUOUSLY WITHOUT REST. CONTINUOUS USE MAY RESULT IN SHORTENING THE LAMP LIFE. TURN OFF THE PROJECTOR AND LET STAND FOR ABOUT AN HOUR IN EVERY 24 HOURS.

**✓ Note:**

- When the On start function is set to "On," the projector will be turned on automatically by connecting the AC power cord to an AC outlet (p.53).
- The running speed of cooling fans is changed according to the temperature inside the projector.
- Do not put the projector in a case before the projector is cooled enough.
- If the WARNING TEMP indicator blinks red, see "Warning Indicators" on page 65.
- The projector cannot be turned on during the cooling period with the READY indicator turned off. You can turn it on again after the READY indicator becomes green again.

## How to Operate the On-Screen Menu

The projector can be adjusted or set via the On-Screen Menu. For each adjustment and setting procedure, refer to the respective sections in this manual.

- 1** Press the MENU button on the side control or the remote control to display the On-Screen Menu.
- 2** Use the Point ◀▶ buttons to select a Menu icon. Use the Point ▲▼ buttons to select an item in the selected menu.
- 3** Press the SELECT button to show the item data. Use the Point ◀▶ buttons to adjust the values.

To close the On-Screen Menu, press the MENU button again.

**✓ Note:**

- The selected item is not active until the SELECT button is pressed.

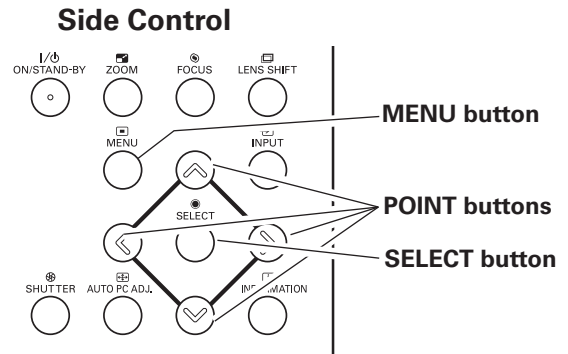

### Remote Control

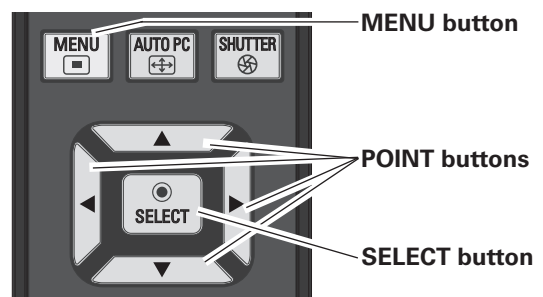

### On-Screen Menu

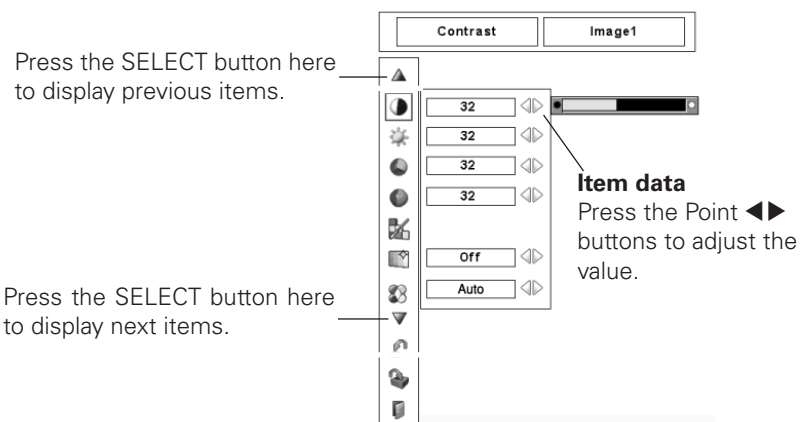
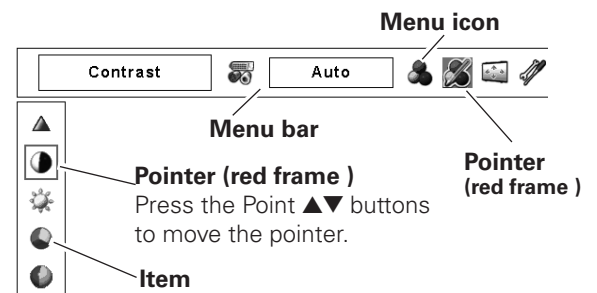

### Menu Bar

For detailed functions of each menu, see “Menu Tree” on pages 69-71.

#### For Computer Source

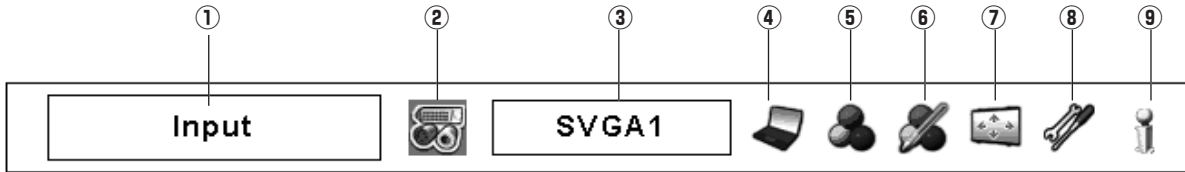

**① Guide Window**

Show the selected Menu of the On-Screen Menu.

**② Input Menu**

Used to select an input source Computer or Video (pp. 31-33).

**③ PC System Menu**

Used to select computer system (p. 34).

**④ PC Adjust Menu**

Used to adjust the parameters to match with the input signal format (pp. 35-37).

**⑤ Image Select Menu**

Used to select an image level among Standard, Real, and Image 1–10 (p. 38).

**⑥ Image Adjust Menu**

Used to adjust the computer image. [Contrast/Brightness/Color management/Auto picture control/Advanced color/Color temp./White balance (R/G/B)/Offset (R/G/B)/Sharpness/Gamma/Reset/Store] (pp. 45-47).

**⑦ Screen Menu**

Used to adjust the size of the image. [Normal/True/Wide/Full screen/Custom/Keystone/Ceiling/Rear/Reset/Digital zoom +/-] (pp.39-40).

**⑧ Setting Menu**

Used to set the projector’s operating configurations (pp. 48-56).

**⑨ Information Menu**

Display the input source information (p. 28).

#### For Video Source

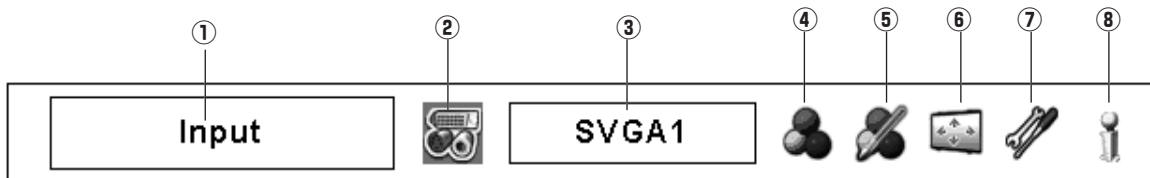

**① Guide Window**

Show the selected Menu of the On-Screen Menu.

**② Input Menu**

Used to select an input source Computer or Video (pp. 31-33).

**③ AV System Menu**

Used to select the system of selected video source (p. 41).

**④ Image Select Menu**

Used to select an image level among Standard, Cinema, and Image 1–10 (p. 42).

**⑤ Image Adjust Menu**

Used to adjust the picture image. [Contrast/Brightness/Color/Tint/Color management/Auto picture control/Advanced color/Color temp./White balance (R/G/B)/Offset (R/G/B)/Sharpness/Gamma/Noise reduction/Progressive/Reset/Store] (pp. 45-47)

**⑥ Screen Menu**

Used to adjust the size of the image. [Normal/Wide/Custom/Keystone/Ceiling/Rear/Reset] (pp. 43-44).

**⑦ Setting Menu**

Used to set the projector’s operating configurations (pp. 48-56).

**⑧ Information Menu**

Display the input source information (p. 28).

## Operating with Projector Control

### Zoom Adjustment

Display "Zoom" on the screen. Press the ZOOM button and then press the Point ▲▼ buttons to zoom in and out the image.

### Focus Adjustment

Display "Focus" on the screen. Press the FOCUS button and then press the Point ▲▼ buttons to adjust the focus of the image.

### Lens Shift Adjustment

Display "Lens shift" on the screen. Use the Point ▲▼◀▶ buttons to position the screen to the desired point without having picture distortion.

The screen can be moved up or down to 50 percent, or sideways up to 10 percent from the central axis of the lens shift.

### Auto PC Adjustment

Operate the Auto PC Adj. function. The computer screen adjustment can be done easily by pressing this button. See page 35 for details.

### Side Control

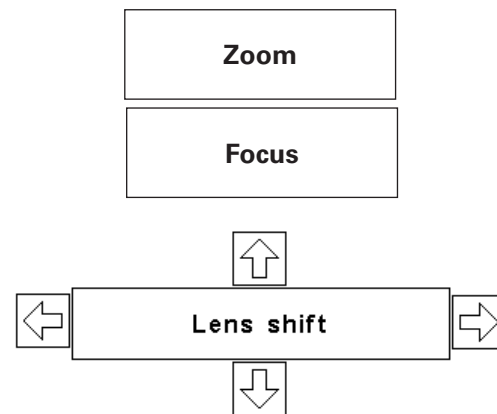
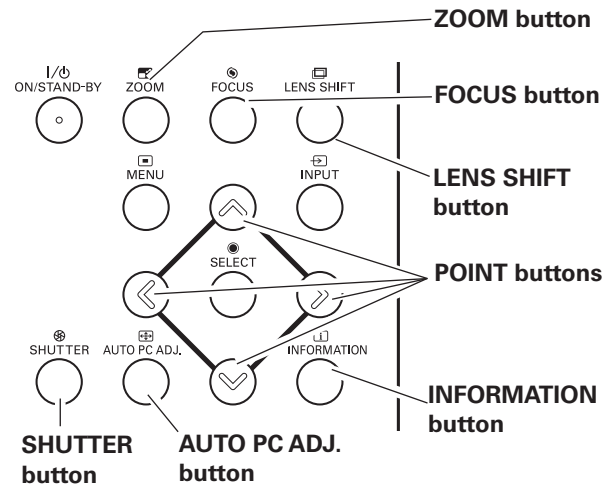

### Shutter Function

Shutter function allows you to completely block out light to the screen. Press the SHUTTER button to close the shutter inside the projector. To open up the shutter, press the SHUTTER button again. Refer to p.55 for detail of setting for the Shutter function.

#### ✓ Note:

- The SHUTTER button on the side control and the remote control cannot be effective when Shutter Protection is "On" in the Setting menu (p.55).
- The SHUTTER indicator on the projector's top lights blue when the shutter is closed (pp.13, 72).
- The projector will shut down automatically when the set time on Shutter management has passed (p55).
- The Power management function does not work when the shutter is closed (p.52).

#### ✓ Note:

- The arrow disappears at the maximum lens shift in each direction.
- The arrow turns red when the lens shift comes to the center position of the screen.

## Information

Information display can be used to confirm the current operating condition of the projector and the signal being projected through the projector.

Press the INFORMATION button to display the information window on the screen. To hide the information window, press the INFORMATION button again or Point ◀▶ buttons.

The information window can also be selected from the menu.

## Information Menu



|                       |                   |
|-----------------------|-------------------|
| Input                 | Input 1           |
|                       | RGB(PC analog)    |
| H-sync freq.          | 15.7 KHz          |
| V-sync freq.          | 59.9 Hz           |
| Screen                | Normal            |
| Language              | English           |
| Lamp mode             |                   |
| Lamp control          |                   |
| Power management      | Ready 5 Min       |
| Shutter management    | Remote control On |
|                       | Projector Off     |
|                       | 180 Min           |
| Security              | Keylock           |
|                       | PIN code lock Off |
| Remote control        | Code 1            |
| Option control No. 10 |                   |

\* The H- and V-sync freq. values described in this figure may be different from the actual values.

## Operating with Remote Control

Using the remote control for some frequently used operations is advisable. Just pressing one of the buttons enables you to make the desired operation quickly without calling up the On-Screen Menu.

### AUTO PC button

Press the AUTO PC button on the remote control to operate the Auto PC Adj. function. The computer screen adjustment can be done easily by pressing this button. See page 35 for details.

### LENS SHIFT button

See page 27 for details.

### ZOOM buttons

Press the ZOOM buttons on the remote control to zoom in and out the image. See page 27 for details.

### FOCUS buttons

Press the FOCUS buttons on the remote control to adjust focus of the image. See page 27 for details.

### FREEZE button

Press the FREEZE button on the remote control to freeze the picture on the screen. To cancel the FREEZE function, press the FREEZE button again or press any other button.

### SCREEN button

Press the SCREEN button on the remote control to select the desired screen size. The selected screen size mode appears on the screen for 4 seconds. See pages 39 to 40 and 43 to 44 for details.

Press and hold the SCREEN button for more than 5 seconds to return all the screen size adjustment setting to the factory default setting.

### D.ZOOM button

Press the D.ZOOM button on the remote control to enter to the Digital zoom +/- mode. See page 40 for details.

### INFO. button

Press the INFO. button on the remote control to display the information window on the screen.

See the previous page for details.

## Remote Control

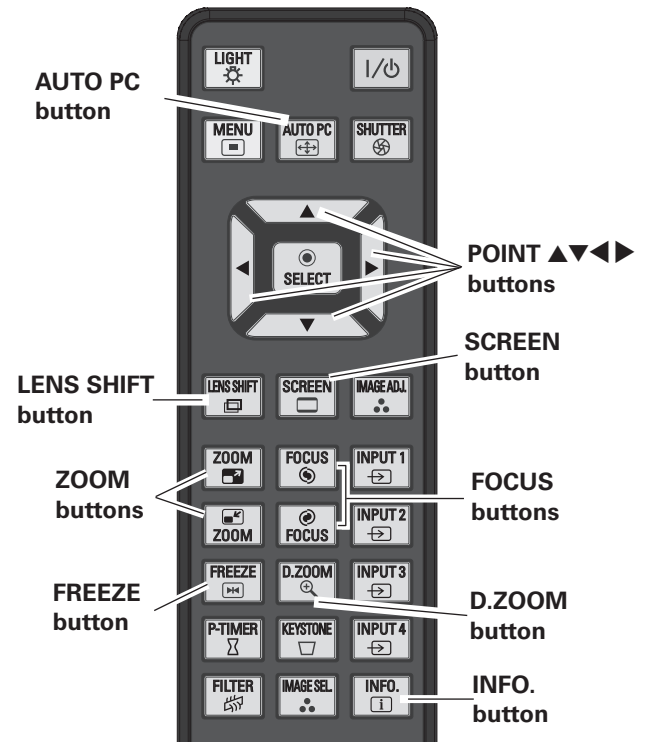

**✓ Note:**

- See the next page for the description of other buttons.

**SHUTTER button**

See pages 27 and 55 for details.

**FILTER button**

Press and hold the FILTER button for more than five seconds to replace the filter mechanically. See page 51 for details.

**✓ Note:**

- The filter cannot be rewind.
- When the filter is replaced, the total accumulated time of the filter use is automatically set to 0.

**IMAGE ADJ. button**

Press the IMAGE ADJ. button on the remote control to adjust an image level of the screen. For more detail, see pp.45-47.

**IMAGE SEL. button**

Press the IMAGE SEL. button on the remote control to select a desired image level of the screen. For more detail, see pp.38, 42.

**P-TIMER button**

Press the P-TIMER button on the remote control. The Timer display “00 : 00” appears on the screen and starts to count time (00 : 00–59 : 59). To stop the P-TIMER, press the P-TIMER button. To cancel the P-TIMER, press the P-TIMER button again.

**KEystone button**

Press the KEystone button on the remote control. The “Keystone” appears on the screen.

Use the Point ▲▼◀▶ buttons to correct keystone distortion. The keystone adjustment can be stored (pp.40, 44).

Reduce the upper width with Point ▲ button.

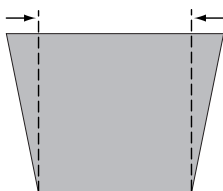

Reduce the lower width with Point ▼ button.

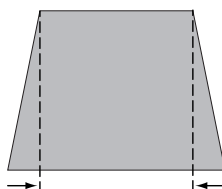

Reduce the left part with Point ◀ button.

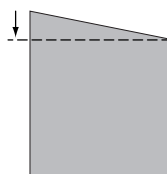

Reduce the right part with Point ▶ button.

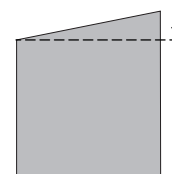

**Remote Control**

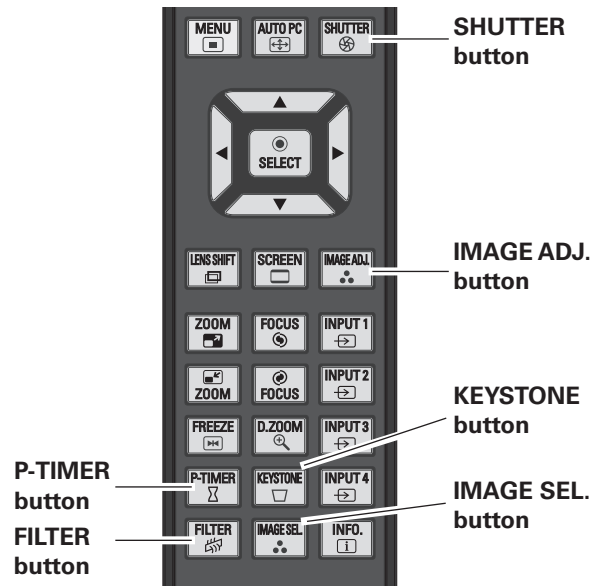

**✓ Note:**

- See the previous page for the description of other buttons.



P-Timer display

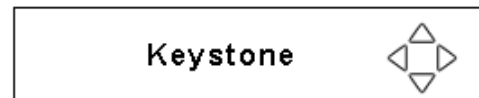

- The white arrows indicate that there is no correction.
- A red arrow indicates the direction of correction.
- An arrow disappears at the maximum correction.
- If you press the KEystone button on the remote control again while the Keystone dialog box is being displayed, the keystone adjustment will be canceled.
- The adjustable range can be limited depending on the input signal.
- “Keystone” disappears after 10 seconds.



## Input

### Side Control

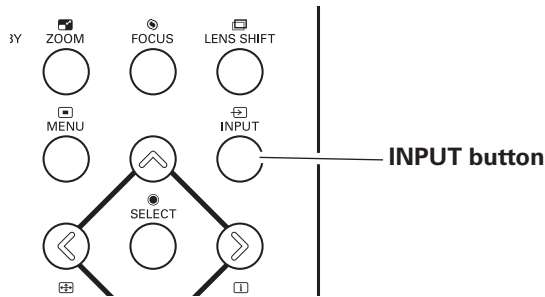

### Side Control button operation

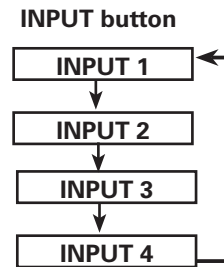

### Side Control Operation

Press the INPUT button on the side control. It switches to INPUT 1, INPUT 2, INPUT 3 and INPUT 4 as you press the INPUT button.

Before using the INPUT button on the side control, you must select a correct input source by On-Screen Menu and the latest input source will be displayed.

### Remote Control

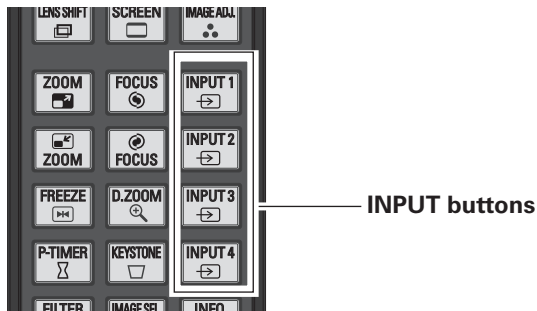

### Remote Control button operation

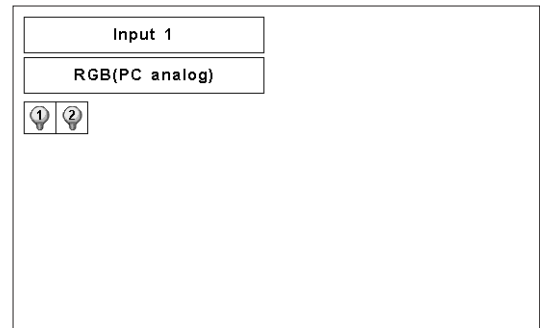

### Remote Control Operation

Press the INPUT 1, INPUT 2, INPUT 3 or INPUT 4 button on the remote control. It switches to INPUT 1, INPUT 2, INPUT 3 or INPUT 4 as you press the INPUT button.

Before using the INPUT button on the remote control, you must select a correct input source by On-Screen Menu and the latest input source will be displayed.

**✓ Note:**

- Empty slots cannot be selected.
- When a slot is empty, the input is displayed in grayout.

## Computer Input Source Selection

### Menu Operation

#### When Selecting the INPUT 1 with DVI/D-sub 15 terminals

- 1** Press the MENU button to display the On-Screen Menu. Use the Point ◀▶ buttons to move the red frame pointer to the INPUT Menu icon.
- 2** Use the Point ▲▼ buttons to move the red arrow pointer to the desired input and then press the SELECT button. Then you can switch to the desired input.
- 3** Press the select button again. The Source Select Menu appears.
- 4** Use the Point ▲▼ buttons to select the desired source and then press the SELECT button.

#### RGB (PC analog)

When your computer is connected to the INPUT 1 (ANALOG) terminal, select RGB (PC analog).

#### RGB (PC digital)

When your computer is connected to INPUT 1 (DIGITAL) terminal, select RGB (PC digital).

#### INPUT MENU

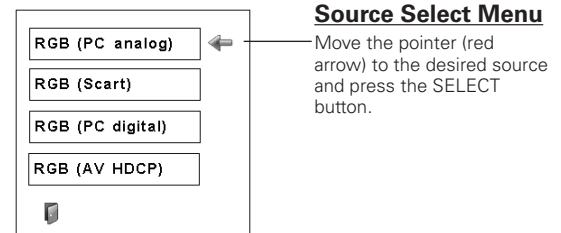
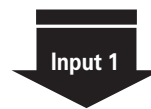
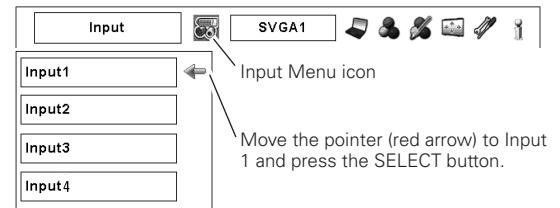

#### When Selecting the INPUT 2 with 5-BNC/Video/S-Video terminals

#### RGB

When your computer is connected to the INPUT 2 (5 BNC INPUT JACKS) terminal, select RGB.

#### INPUT MENU

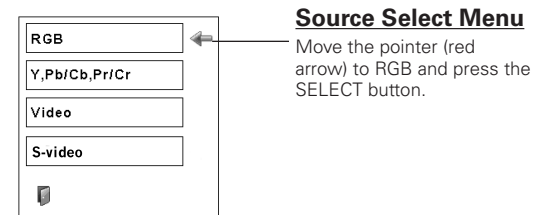
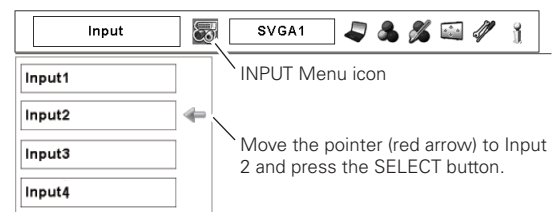

**✓ Note:**

- When a slot is empty, the input is displayed in greyout.

## Video Input Source Selection

### Menu Operation

#### When Selecting the INPUT 1 with DVI/D-sub 15 terminals

When connecting to video equipment, select the type of Video source in the Source Select Menu.

##### RGB (Scart)

When scart video equipment is connected to the INPUT 1 (ANALOG) terminal, select RGB (Scart).

##### RGB (AV HDCP)

If the HDCP-compatible signal source is connected to the INPUT 1 (DIGITAL) terminal, select RGB (AV HDCP).

#### INPUT MENU

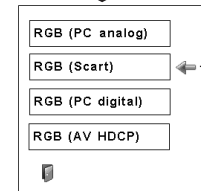
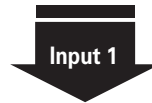
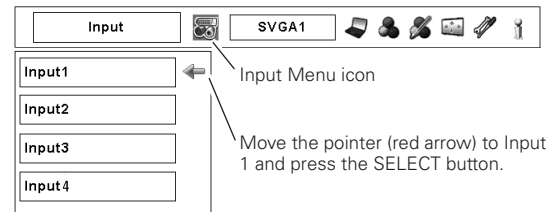

#### Source Select Menu

Move the pointer (red arrow) to RGB (Scart) or RGB (AV HDCP) and press the SELECT button.

#### When Selecting the INPUT 2 with 5-BNC/Video/S-Video terminals

When connecting to video equipment, select the type of Video source in the Source Select Menu.

##### Y, Pb/Cb, Pr/Cr

When the video input signal is connected to the Y-Pb/Cb-Pr/Cr jacks, select Y, Pb/Cb, Pr/Cr.

##### Video

When the video input signal is connected to the VIDEO jack, select Video.

##### S-Video

When the video input signal is connected to the S-VIDEO jack, select S-Video.

#### INPUT MENU

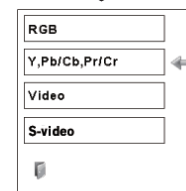
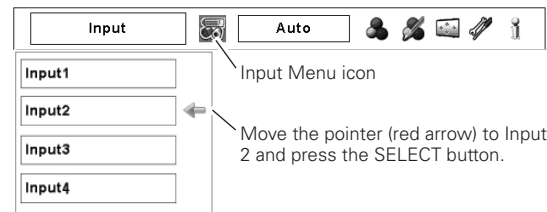

#### Source Select Menu

Move the pointer (red arrow) to Y, Pb/Cb, Pr/Cr, Video, or S-video and press the SELECT button.

#### ✓ Note:

- HDCP (High-bandwidth Digital Content Protection) is a system for protecting digital entertainment content which is delivered by DVI (Digital Visual Interface) from being copied. The specification of HDCP is decided and controlled by Digital Content Protection, LLC. Should the specification be changed, this projector may not display the digital content protected by HDCP.
- When a slot is empty, the input is displayed in grayout.

## Computer System Selection

### Automatic Multi-Scan System

This projector automatically tunes to various types of computers (refer to “Compatible Computer Specifications” on pages 75-76). If a computer is selected as a signal source, this projector automatically detects the signal format and tunes to project a proper image without any additional settings. (Some computers need to be set manually.)

One of the following messages may appear when:

- Auto** When the projector cannot recognize the connected signal conforming to the provided PC Systems, the “Auto” is displayed on the PC System Menu icon and the Auto PC Adjustment function works to display proper images. If the image is not projected properly, a manual adjustment is required (pp. 36–37).
- There is no signal input from the computer. Check the connection between your computer and the projector. (See “Troubleshooting” on page 66.)
- Mode 1** The preset system is manually adjusted in the PC Adjust Menu. The adjusted data can be stored in the Mode 1–10 (pp. 36-37).
- SVGA 1** PC systems provided in this projector is chosen. The projector chooses a proper system provided in the projector and displays it.

\* Mode 1 and SVGA 1 are examples.

### Selecting Computer System Manually

PC system can also be selected manually.

- 1** Press the MENU button to display the On-Screen Menu. Use the Point ◀▶ buttons to move the red frame pointer to the PC System Menu icon.
- 2** Use the Point ▲▼ buttons to move the red arrow pointer to the desired system, and then press SELECT button.

#### PC SYSTEM MENU

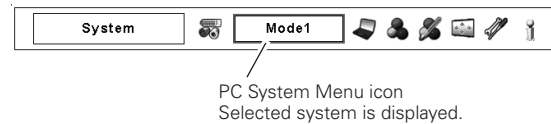

#### PC SYSTEM MENU

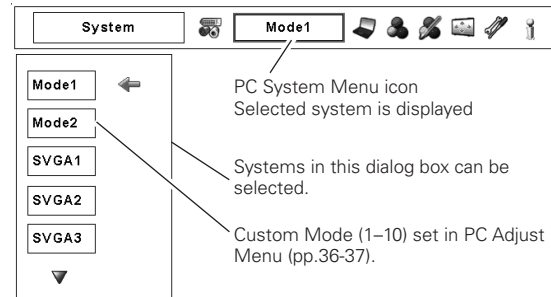

## Auto PC Adjustment

Auto PC Adjustment function is provided to automatically adjust Fine sync, Total dots, Horizontal and Vertical positions to conform to your computer.

### Direct Operation

The Auto PC adjustment function can be operated directly by pressing the AUTO PC button on the remote control or the AUTO PC ADJ. button on the side control.

### Remote Control

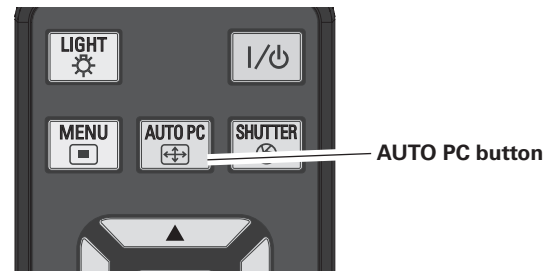

### Side Control

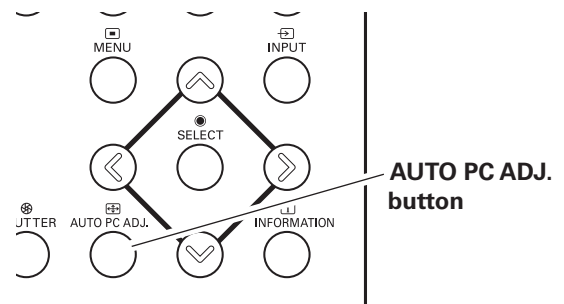

### Menu Operation



#### Auto PC adj.

- 1 Press the MENU button to display the On-Screen Menu. Use the Point ◀▶ buttons to move the red frame pointer to the PC Adjust Menu icon.
- 2 Use the Point ▲▼ buttons to move the red frame pointer to the AUTO PC adj. icon and then press the SELECT button twice.

#### To store the adjusted parameters.

The adjusted parameters of the Auto PC Adjustment can be stored in the projector. Once the parameters are stored, the setting can be done just by selecting Mode in PC SYSTEM Menu (p.34). See MANUAL PC ADJUSTMENT on pages 36-37.

#### ✓ Note:

- Fine sync, Total dots, Horizontal and Vertical position of certain computers cannot be fully adjusted with the Auto PC Adjustment function. When the image is not provided properly with this operation, manual adjustments are required (pp. 36-37).
- Auto PC Adjustment cannot be operated in Digital Signal Input on the DVI terminal and "480p," "575p," "480i," "575i," "720p," "1035i," or "1080i" is selected on the PC SYSTEM Menu.
- Depending on the condition of signals and the type and length of cables, the signals may not be properly viewed.

### PC ADJUST MENU

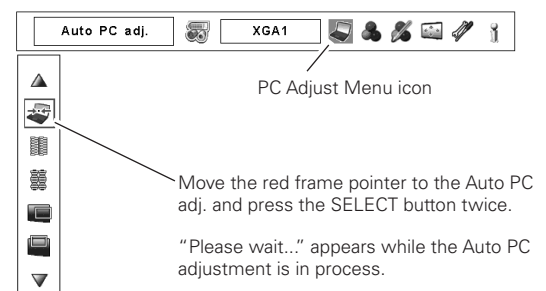

## Manual PC Adjustment

Some computers employ special signal formats which may not be tuned by Multi-Scan system of this projector. Manual PC Adjustment enables you to precisely adjust several parameters to match those special signal formats. The projector has 10 independent memory areas to store those manually adjusted parameters. It allows you to recall the setting for a specific computer.

✓ **Note:** The PC Adjust Menu cannot be operated when the digital signal input on the DVI terminal is selected on PC System Menu.

- 1 Press the MENU button to display the On-Screen Menu. Use the Point ◀▶ buttons to move the red frame pointer to the PC Adjust Menu icon.
- 2 Use the Point ▲▼ buttons to move the red frame pointer to the desired item and then press the SELECT button to display the adjustment dialog box. Use the Point ◀▶ buttons to adjust the setting value.

### Fine sync

Use the Point ◀▶ buttons to adjust the value, eliminating a flicker from the image displayed (from 0 to 31).

### Total dots

Use the Point ◀▶ buttons to adjust the number of total dots in one horizontal period to match your PC image.

### Position H

Use the Point ◀▶ buttons to adjust the horizontal picture position.

### Position V

Use the Point ◀▶ buttons to adjust the vertical picture position.

### Current mode

Press the SELECT button to show H-sync freq. and V-sync freq. of the connected computer.

### Clamp

Use the Point ◀▶ buttons to adjust the clamp level. When the image has dark bars, try this adjustment.

### Display area H

Use the Point ◀▶ buttons to adjust the horizontal area displayed by this projector.

### Display area V

Use the Point ◀▶ buttons to adjust the vertical area displayed by this projector.

## PC ADJUST MENU

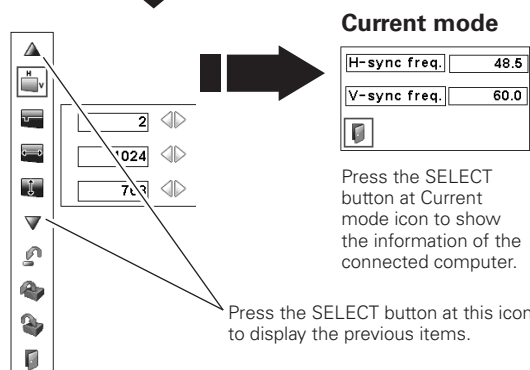
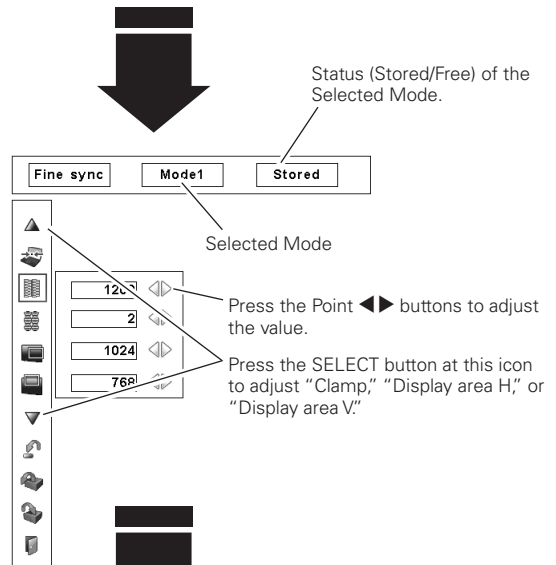
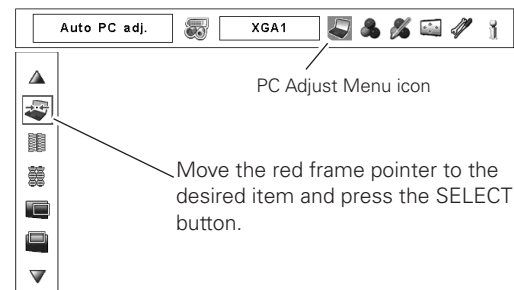



**Reset**

To reset the adjusted data, select Reset and press the SELECT button. A confirmation box appears and then select [Yes]. All adjustments will return to their previous figures.



**Mode free**

To clear the adjusted data, select Mode free and then press the SELECT button. Move the red arrow pointer to the Mode that you want to clear and then press the SELECT button.



**Store**

To store the adjusted data, select Store and then press the SELECT button. Move the red arrow pointer to one of the Mode 1 to 10 in which you want to store, and then press the SELECT button.



**Quit**

Exit the PC Adjust Menu.

**To clear the adjusted data.**

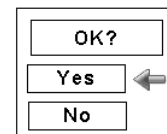
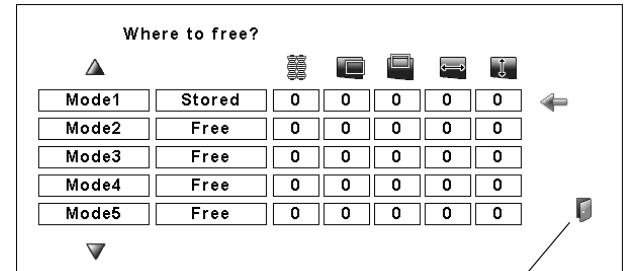

Close this dialog box.  
Confirmation box appears and then select [Yes].

**To store the adjusted data.**

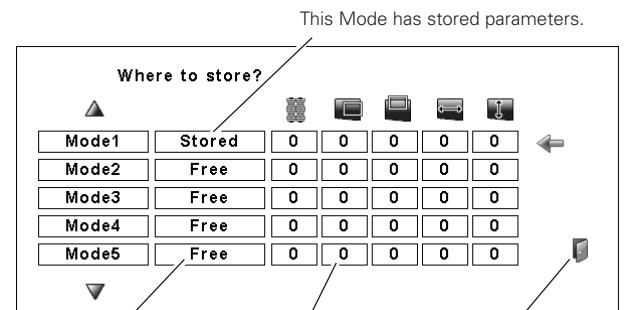

Vacant

Values of "Total dots," "Position H," "Position V," "Display area H," and "Display area V."

Close this dialog box.

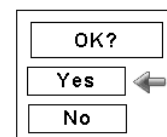

Confirmation box appears and then select [Yes].

## Image Level Selection

### Direct Operation

Press the IMAGE SEL. button on the remote control to select the desired image level.

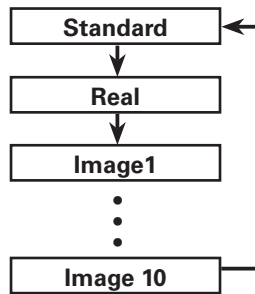

### Remote Control

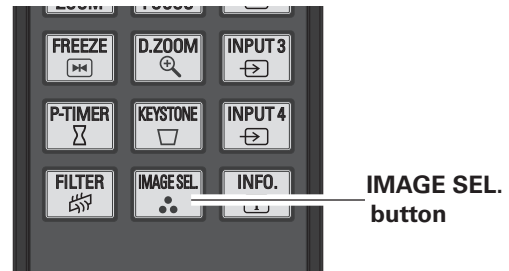

### Menu Operation

- 1** Press the MENU button to display the On-Screen Menu. Use the Point ◀▶ buttons to move the red frame pointer to the Image Select Menu icon.
- 2** Use the Point ▲▼ buttons to move the red frame pointer to the desired image level and then press the SELECT button.



Normal picture level preset on the projector.



Picture level with improved halftone for graphics.



User preset picture adjustment in the Image Adjust Menu (p. 47).

### IMAGE SELECT MENU

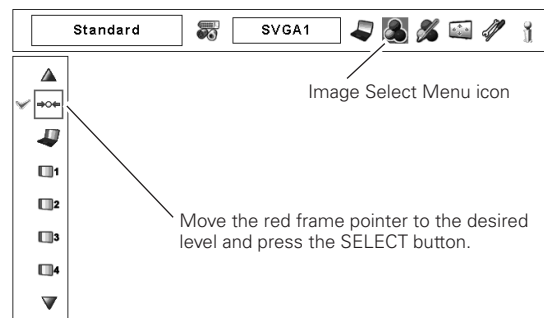



## Screen Size Adjustment

Select the desired screen size that conforms to the input signal source.

- 1 Press the MENU button to display the On-Screen Menu. Use the Point ◀▶ buttons to move the red frame pointer to the Screen Menu icon.
- 2 Use the Point ▲▼ buttons to move the red frame pointer to the desired function and then press the SELECT button.



### Normal

Provide the image at the normal computer aspect ratio of 4:3.



### True

Provide the image in its original size. When the original image size is larger than the screen size (1024 x 768), the projector enters to the panning mode automatically. Use the Point ▲▼◀▶ buttons to pan the image. When adjusted, the arrows will turn red. When reached to the correction limits, the arrows will disappear.



### Wide

Provide the image to fit the wide video aspect ratio (16:9) by expanding the image width uniformly. This function can be used to provide the squeezed video signal at 16:9.



### Full screen

Provide the full screen image.



### Custom

Adjust the screen scale and position manually with this function.

Press the SELECT button at Custom and the "Custom" is displayed on the screen for a few seconds. To display the Aspect dialog box, press the SELECT button at Custom again and then the Aspect dialog box appears.

- Scale H/V ..... Adjust the Horizontal/Vertical screen scale.
- H&V ..... When set to "On," the aspect ratio is fixed. The "Scale V" appears dimmed and becomes unavailable. Adjust "Scale H," then the screen scale is automatically modified based on the aspect ratio.
- Position H/V ..... Adjust the Horizontal/Vertical screen position.
- Common ..... Save the adjusted scale to all the inputs. Press the SELECT button at Common to display a confirmation box. To save the scale, press the SELECT button at "Yes." When Custom is selected, the saved scale is used.
- Reset ..... Reset the all adjusted values. Press the SELECT button at Reset to display a confirmation box. To reset, press the SELECT button at "Yes."

### SCREEN MENU

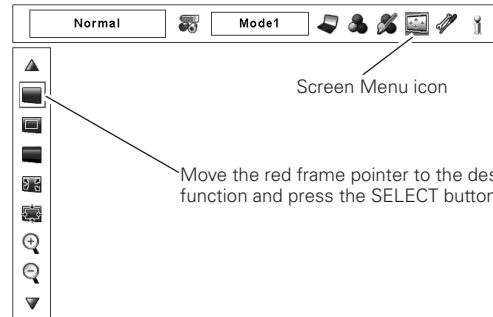

#### ✓ Note:

- True, Full screen, and Digital zoom +/- cannot be selected when no signal is detected in the PC System Menu (p.34).
- The projector cannot display and resolution higher than 1920 x 1200. If your computer's screen resolution is higher than 1920 x 1200, lower the resolution before connecting the projector.
- The image data other than XGA (1024 x 768) is modified to fit the screen size in initial mode.
- The panning function may not operate properly if the stored Mode in the PC Adjust Menu is used (p. 37).

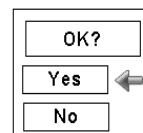
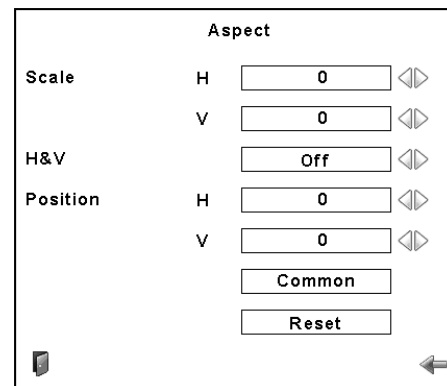

Press the SELECT button at Common or Reset, to display a confirmation box.

#### ✓ Note:

- When no signal is detected, "Normal" is set automatically and the Aspect dialog box disappears.
- The adjustable range for Scale H/V and Position H/V is limited depending on the input signal.



## Keystone

This function is used to store or reset the keystone correction when the Main On/Off Switch is pressed to Off or the AC power cord is unplugged. Use the Point ◀▶ buttons to switch between each option.

Store . . . Keep the keystone correction even when the Main On/Off Switch is pressed to Off or the AC power cord is unplugged.

Reset . . . Release the keystone correction when the Main On/Off Switch is pressed to Off or the AC power cord is unplugged.

To correct keystone distortion, press the Select button. The Keystone dialog box appears. Use the Point ▲▼◀▶ buttons to correct keystone distortion (p.30).



## Ceiling

When this function is set to "On," the picture is top/bottom and left/right reversed. This function is used to project the image from a ceiling-mounted projector.



## Rear

When this function is set to "On," the picture is left/right reversed. This function is used to project the image from the rear of the screen.



## Reset

This function returns all adjusted values to the factory default settings. Press the SELECT button at Reset to display a confirmation box. To reset, press the SELECT button at "Yes."



## Quit

Exit the Screen Size Adjustment Menu.

## For zooming in and out the images



## Digital zoom +

Select Digital zoom +. The On-Screen Menu disappears and "D. zoom +" appears. Press the SELECT button to expand the image size. Use the Point ▲▼◀▶ buttons to pan the image. The Panning function can work only when the image is larger than the screen size.

You can also enter the Digital zoom + mode by pressing the D.ZOOM button on the remote control.



## Digital zoom -

Select Digital zoom -. The On-Screen Menu disappears and "D.zoom -" appears. Press the SELECT button to compress the image size.

You can also enter the Digital zoom - mode by pressing the D.ZOOM button on the remote control.

To exit the Digital Zoom +/- mode, press any button except the D.ZOOM , SELECT, and Point buttons.

## SCREEN MENU

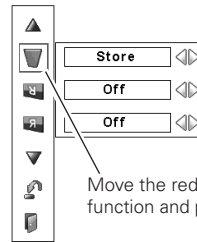

Move the red frame pointer to the desired function and press the SELECT button.

## Ceiling

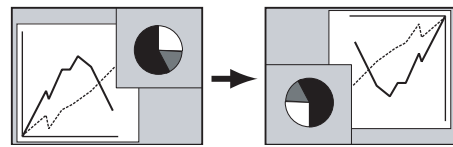

## Rear

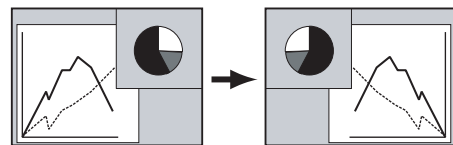

### ✓ Note:

- The panning function may not operate properly if the stored Mode in the PC Adjust Menu is used (p. 37).
- The minimum compression ratio can be limited depending on the input signal or when the Keystone function is working or when the custom is selected for the screen size.
- Digital zoom +/- cannot be selected when Full screen or True is selected.

## Video System Selection

- 1** Press the MENU button to display the On-Screen Menu. Use the Point ◀▶ buttons to move the red frame pointer to the AV System Menu icon.
- 2** Use the Point ▲▼ buttons to move the red arrow pointer to the desired system and then press the SELECT button.

### Video Jack or S-Video Jack

#### Auto

The projector automatically detects an incoming video system, and adjusts itself to optimize its performance.

#### PAL/SECAM/NTSC/NTSC4.43/PAL-M/PAL-N

If the projector cannot reproduce proper video image, select a specific broadcast signal format from among PAL, SECAM, NTSC, NTSC 4.43, PAL-M, and PAL-N.

#### AV SYSTEM MENU (VIDEO OR S-VIDEO)

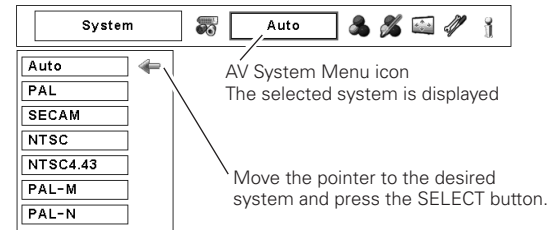

### Y, Pb/Cb, Pr/Cr Jacks

#### Auto

The projector automatically detects an incoming video signal, and adjusts itself to optimize its performance.

When the Video System is 1035i or 1080i, select the system manually.

#### COMPONENT VIDEO SIGNAL FORMAT

If the projector cannot reproduce proper video image, select a specific component video signal format from among 480i, 575i, 480p, 575p, 720p, 1035i, and 1080i.

#### AV SYSTEM MENU (COMPONENT VIDEO)

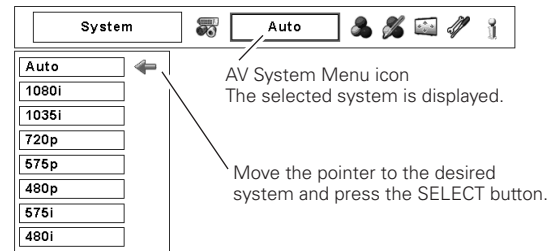

**✓ Note:**

- The AV System menu cannot be selected when selecting RGB(Scart).

## Image Level Selection

### Direct Operation

Press the IMAGE SEL. button on the remote control to select the desired image level.

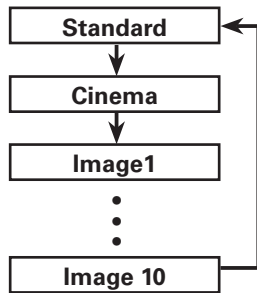

### Remote Control

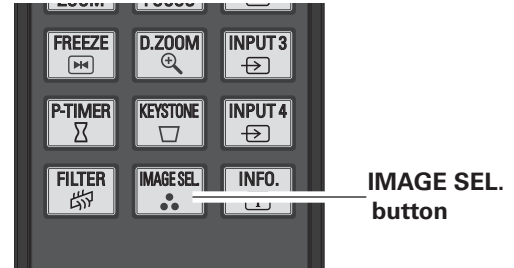

### Menu Operation

- 1 Press the MENU button to display the On-Screen Menu. Use the Point ◀▶ buttons to move the red frame pointer to the Image Select Menu icon.
- 2 Use the Point ▲▼ buttons to move the red frame pointer to the desired image level and then press the SELECT button.



**Standard**

Normal picture level preset on the projector.



**Cinema**

Picture level adjusted with fine tone.



**IMAGE 1-10**

User preset picture adjustment in the Image Adjust Menu (p. 47).

### IMAGE SELECT MENU

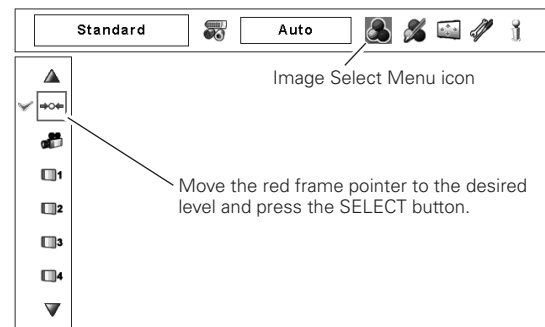

## Screen Size Adjustment

- 1 Press the MENU button to display the On-Screen Menu. Use the Point ◀▶ buttons to move the red frame pointer to the Screen Menu icon.
- 2 Use the Point ▲▼ buttons to move the red frame pointer to the desired function and then press the SELECT button.



### Normal

Provide the image at the normal video aspect ratio of 4:3.



### Wide

Provide the image at the wide screen ratio of 16:9.



### Custom

Adjust the screen scale and position manually with this function.

Press the SELECT button at Custom and the "Custom" is displayed on the screen for a few seconds. To display the Aspect dialog box, press the SELECT button at Custom again and then the Aspect dialog box appears.

- Scale H/V ..... Adjust the Horizontal/Vertical screen scale.
- H&V ..... When set to "On," the aspect ratio is fixed. The "Scale V" appears dimmed and becomes unavailable. Adjust "Scale H," then the screen scale is automatically modified based on the aspect ratio.
- Position H/V ..... Adjust the Horizontal/Vertical screen position.
- Common ..... Save the adjusted scale to all the inputs. Press the SELECT button at Common to display a confirmation box. To save the scale, press the SELECT button at "Yes." When Custom is selected, the saved scale is used.
- Reset ..... Reset the all adjusted values. Press the SELECT button at Reset to display a confirmation box. To reset, press the SELECT button at "Yes."

### SCREEN MENU

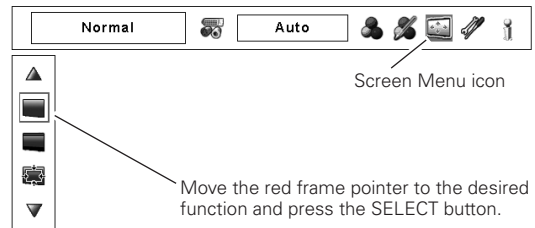

#### ✓ Note:

- Wide cannot be operated when "720p," "1035i," or "1080i" is selected on AV System Menu (p.41).

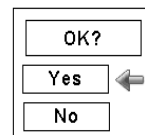
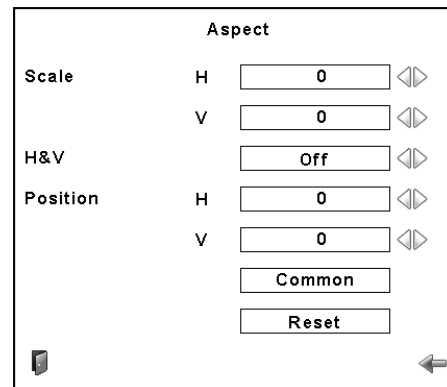

Press the SELECT button at Common or Reset, to display a confirmation box.

#### ✓ Note:

- When no signal is detected, "Normal" is set automatically and the Aspect dialog box disappears.
- The adjustable range for Scale H/V and Position H/V is limited depending on the input signal.



## Keystone

This function is used to store or reset the keystone correction when the Main On/Off Switch is pressed to Off or the AC power cord is unplugged. Use the Point ◀▶ buttons to switch between each option.

Store . . . Keep the keystone correction even when the Main On/Off Switch is pressed to Off or the AC power cord is unplugged.

Reset . . . Release the keystone correction when the Main On/Off Switch is pressed to Off or the AC power cord is unplugged.

To correct keystone distortion, press the Select button. The Keystone dialog box appears. Use the Point ▲▼◀▶ buttons to correct keystone distortion (p.30).



## Ceiling

When this function is set to "On," the picture is top/bottom and left/right reversed. This function is used to project the image from a ceiling-mounted projector.



## Rear

When this function is set to "On," the picture is left/right reversed. This function is used to project the image from the rear of the screen.



## Reset

This function returns all adjusted values to the factory default settings. Press the SELECT button at Reset to display a confirmation box. To reset, press the SELECT button at "Yes."



## Quit

Exit the Screen Size Adjustment Menu.

### SCREEN MENU

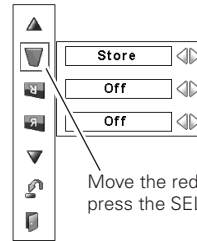

Move the red frame pointer to a function and press the SELECT button.

### Ceiling

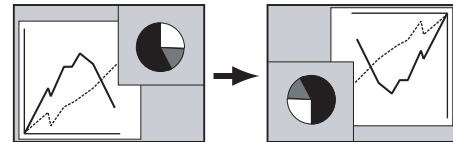

### Rear

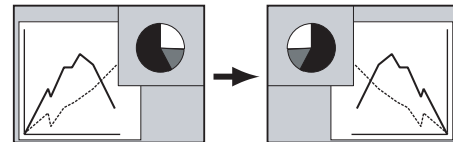

## Image Adjustment

- 1 Press the MENU button to display the On-Screen Menu. Use the Point ◀▶ buttons to move the red frame pointer to the Image Adjust Menu icon.
- 2 Use the Point ▲▼ buttons to move the red frame pointer to the desired item and then press the SELECT button to display the adjustment dialog box. Use the Point ◀▶ buttons to adjust the setting value.



### Contrast

Press the Point ◀ button to decrease contrast; press the Point ▶ button to increase the contrast (from 0 to 63).



### Brightness

Press the Point ◀ button to decrease the brightness; press the Point ▶ button to increase the brightness (from 0 to 63).



### Color \*

Press the Point ◀ button to decrease the intensity of the color; press the Point ▶ button to increase the intensity of the color (from 0 to 63).



### Tint \*

Press the Point ◀▶ buttons to adjust the tint value to obtain proper color balance (from 0 to 63).



### Color Management

The Color Management function can be used to adjust the LEVEL, PHASE, and GAMMA of the selected display colors (except for black, white, and gray) on the screen and replace these colors with other colors if required.

You can store up to eight (8) color management data.

- 1 Use the Point ▲▼ buttons to move the red frame pointer to Color Management, and then press the SELECT button. The projected image freezes, and the COLOR MANAGEMENT POINTER appears.
- 2 Use the Point ▲▼◀▶ buttons to move the pointer to the spot where you want to adjust the color and then press the SELECT button. The COLOR SELECTION window appears, and the color in the center of the pointer is selected and you can adjust the color.
- 3 Use the Point ▲▼◀▶ buttons to adjust the LEVEL and PHASE of the color, and then press the SELECT button to confirm the setting. Then use the Point ▲▼ buttons to adjust the GAMMA for the color and press the SELECT button to accept the setting. After adjusting, press the SELECT button to go to the COLOR MANAGEMENT LIST.

## COLOR SELECTION MODE

### LIST

Go to the COLOR MANAGEMENT LIST.

## IMAGE ADJUST MENU

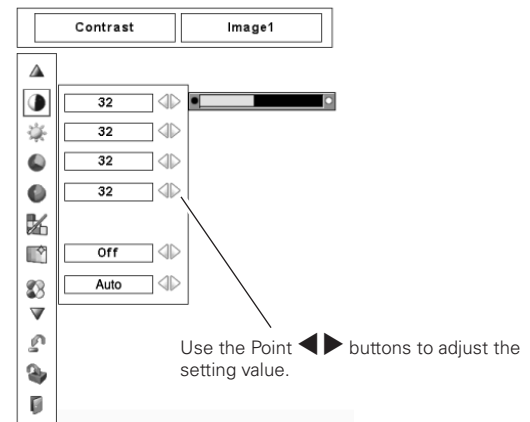
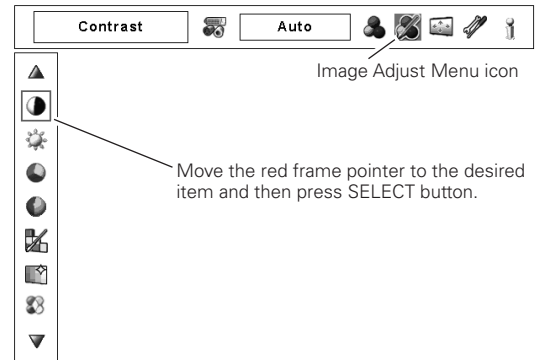

## POINTER MODE

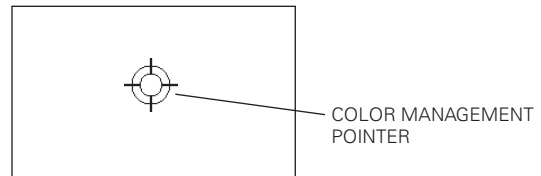

### ✓ Note:

- \* Displayed in grayout in the computer Input.
- Tint cannot be selected when the video system is PAL, SECAM, PAL-M, or PAL-N (p.41).
- Color management is displayed in grayout when there is no signal.

COLOR SELECTION MODE (continued)

**COLOR M.**

Return to the COLOR MANAGEMENT POINTER. (If you press the MENU button on the side control or the remote control, it returns to the COLOR MANAGEMENT POINTER and you will need to reselect and readjust the color.)

**MENU**

Return to the IMAGE ADJUST Menu. Any settings that have been changed will not be stored. To store the changed settings, be sure to select "LIST" and go to the COLOR MANAGEMENT LIST.

- 4 In the COLOR MANAGEMENT LIST, the adjusted color data are checkmarked. You can decide whether or not to apply the adjusted color data in the list to the projected image (see below).

LIST MODE



Clear the check mark if you do not want to apply the adjusted color data; select the check mark and then press the SELECT button. The check mark disappears.

**COLOR PALETTE**

Return to the COLOR SELECTION mode so that you can readjust the setting for the color in that line. (This option is not available if the check mark is cleared.)

**DEL**

Select the DEL box if you want to delete the adjusted data. Press the SELECT button and a confirmation box appears and then select [Yes].

**ALL DEL**

Delete all the data in the list. Press the SELECT button and a confirmation box appears and then select [Yes].

**MENU**

The same function as stated above.

**COLOR M.**

The same function as stated above.



**Auto picture control**

Use the Point ◀▶ buttons to select the desired Auto picture control position (Off, L1 or L2).

- Off . . . . Auto picture control OFF position.
- L1 . . . . Auto picture control LEVEL 1 position.
- L2 . . . . Auto picture control LEVEL 2 position.



**Advanced color**

Use the Point ◀▶ buttons to select the advanced color mode.

- Off . . . . Advanced color mode is "Off".
- Auto . . . . Advanced color according to the type of image.



**Color temp.**

Use the Point ◀▶ buttons to select the desired Color temp. level (XLow, Low, Mid, or High).

COLOR SELECTION MODE

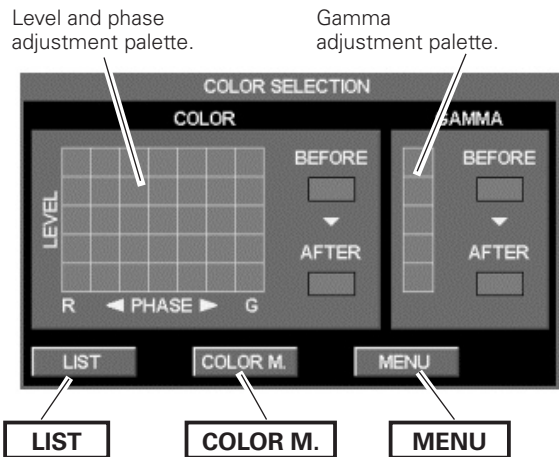

LIST MODE

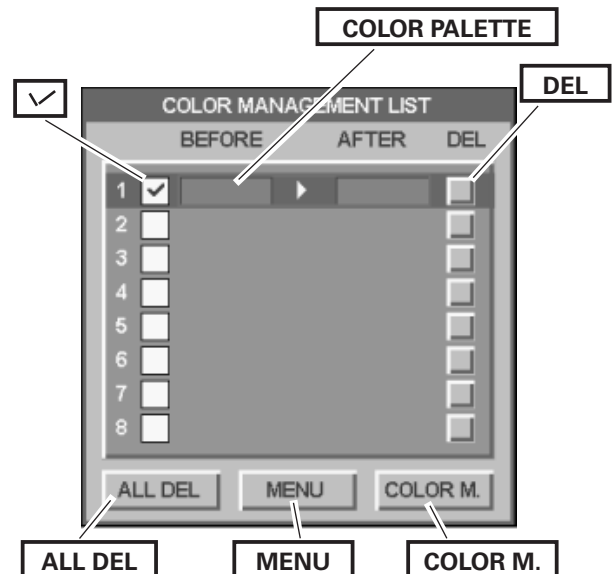





**White balance (Red/Green/Blue)**

Press the Point ◀ button to lighten red/green/blue tone; press the Point ▶ button to deepen red/green/blue tone (from 0 to 63).



**Offset (Red/Green/Blue)**

Press the Point ◀ button to lighten red/green/blue tone of the black level of an image; press the Point ▶ button to deepen red/green/blue tone of the black level of an image (from 0 to 63).



**Sharpness**

Press the Point ◀ button to decrease the sharpness of the image; press the Point ▶ button to increase the sharpness of the image (from 0 to 31).



**Gamma**

Use the Point ◀▶ buttons to adjust the gamma value to obtain a better balance of contrast (from 0 to 15).



**Noise reduction \***

Noise interference on the screen can be reduced. Press the Point ◀▶ buttons to change the noise reduction mode.

- Off . . . . Noise reduction mode is "Off"
- On . . . . Noise reduction mode is "On"



**Progressive \***

An interlaced video signal can be displayed in progressive mode.

Press the Point ◀▶ buttons to change the progressive scan mode.

- Off . . . . Progressive scan mode is "Off."
- On . . . . Progressive scan mode is "On."

Film . . . . For watching a film. With this function, the projector reproduces pictures faithful to the original film quality.

**✓ Note:**

- Picture is distorted at the moment of On/Off /Film switching.



**Reset**

To reset the adjusted data, select Reset and press the SELECT button. A confirmation box appears and then select [Yes]. All adjustments will return to their previous figures.



**Store**

To store the adjusted data, move the red frame pointer to the Store icon and press the SELECT button. The Image Level Menu appears. Move the red arrow pointer to any of the Image 1 to 10 in which you want to set and press the SELECT button. A confirmation box appears and then select [Yes].



**Quit**

Exit the Image Adjust Menu.

**✓ Note:**

- \* Displayed in grayout in the computer Input.
- When the White balance Red, Green, or Blue is adjusted, the Color temp. level will change to "Adj."
- The Film mode in the Progressive function cannot be selected when the video signal format is 1080i or 1035i.
- Progressive cannot be selected when "480p," "575p," or "720p" is selected (p.41).

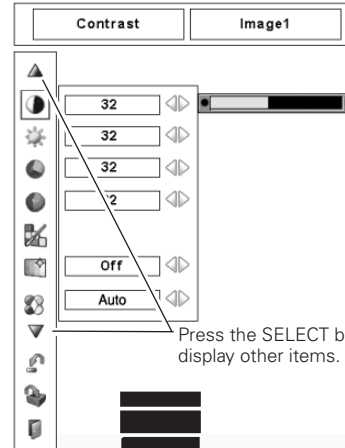

Press the SELECT button at this icon to display other items.

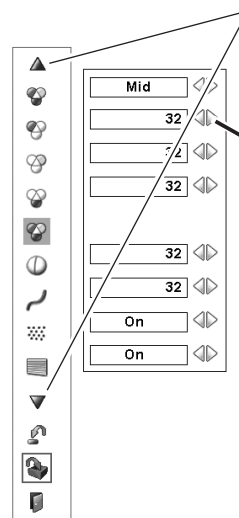

Press the SELECT button at this icon to display the previous items.

Press the Point ◀▶ buttons to adjust the setting value.

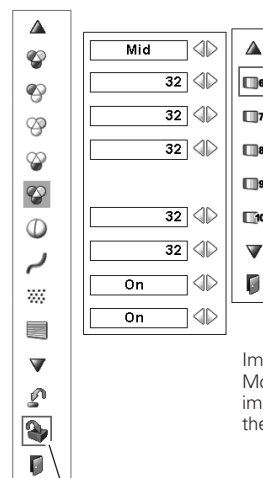

Image Level Menu  
Move the red frame pointer to an image item to be set and then press the SELECT button.

Store icon  
Press the SELECT button at this icon to store the adjustment.

## Setting

This projector has a Setting menu that allows you to set up other various functions.

- 1** Press the MENU button to display the On-Screen Menu. Use the Point ◀▶ buttons to move the red frame pointer to the Setting Menu icon.
- 2** Use the Point ▲▼ buttons to move the red frame pointer to the desired item and then press the SELECT button. The Setting dialog box appears.

### Language

The language used in the On-Screen Menu is available in English, German, French, Italian, Spanish, Portuguese, Dutch, Swedish, Russian, Chinese, Korean, or Japanese.

### Menu

This function allows you to adjust the position of the On-Screen Display and the value adjustment bar in the Picture Image Adjustment Menu.

### Position

This function is used to adjust the On-Screen Menu display position. Press the SELECT button and the adjustment screen appears (arrows appear). Use the Point ▲▼◀▶ buttons to adjust the position. After making the adjustment, press the SELECT button to return to the Menu screen.

### Simple menu

When this function is set to "On," the value adjustment bar in the Picture Image Adjustment Menu appears on the screen.

### Display

This function decides whether to display On-Screen Displays.

- On . . . . . Show all the On-Screen Displays. Use this function when you want to project images after the lamp becomes bright enough. The factory default setting is in this option.
- Countdown Off. . . Show the input image instead of the countdown when turning on the projector. Use this function when you want to project the image as early as possible even when the lamp is not bright enough.
- Off . . . . . Hide the On-Screen Displays except:
  - On-Screen Menu
  - "Power off?" (p.24)
  - Color management operation screen (pp.45-46)
  - "No signal" for Power management (p.52)
  - P-TIMER (p.30)
  - "Please wait...." for Auto PC adjustment (p.35)
  - Arrows for panning mode

### Background

The selected background screen will be displayed when no input signal is detected.

- Blue . . . Blue colored background.
- User . . . The image you captured.
- Black . . . Black colored background.

### SETTING MENU (Language)

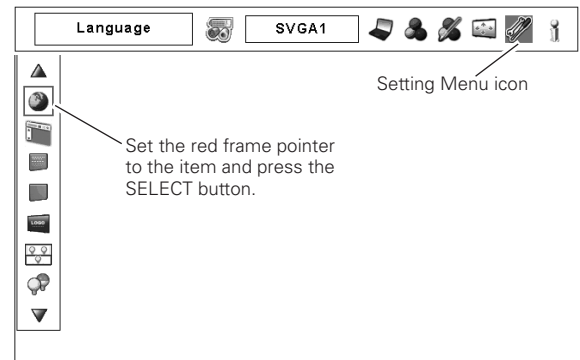

Press the SELECT button at Language, then the Language Menu appears.

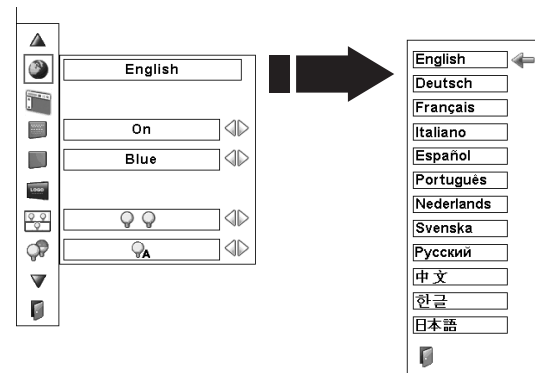

### Menu

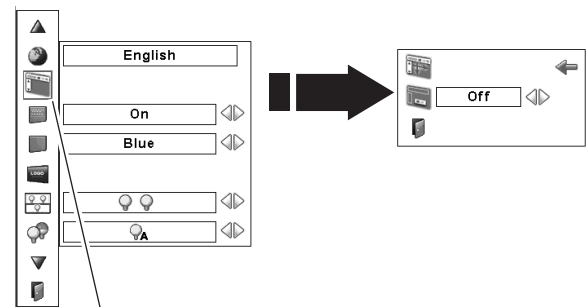

#### ✓ Note:

- "User" cannot be selected when the image is not captured.



**Logo**

This function allows you to customize the screen logo with Logo select, Capture, and Logo PIN code lock functions.

**✓ Note:**

- When "On" is selected in the Logo PIN code lock function, Logo select and Capture functions cannot be selected.



**Logo select**

This function decides on the starting-up display from among the following options.

- User . . . Show the image you captured.
- Default . Show the factory-set logo.
- Off . . . . Show the countdown display only.



**Capture**

This function enables you to capture an image being projected to use it for a starting-up display or interval of presentations.

Select Capture and press the SELECT button. A confirmation box appears and select [Yes] to capture the projected image.

After capturing the projected image, go to the Logo select function and set it to "User". Then the captured image will be displayed the next time you turn on the projector.

To cancel the Capture function, select [No].

**✓ Note:**

- Before capturing an image, select "Standard" in the Image Select Menu to capture a proper image (pp. 38, 42).
- A signal from a computer can be captured up to XGA (1024 x 768).
- Certain signals may not be captured properly.
- When capturing the image that has been adjusted by the Keystone function, the adjusted data is automatically reset and the projector captures an image without keystone correction.
- When starting to capture a new image, the previously stored image is cleared even if you cancel the capturing.
- Once you exit the Logo Menu after setting the Logo lock to "On," you are required to enter the PIN code every attempting to change the Logo setting.
- "User" cannot be selected when the image is not captured.

**Logo**

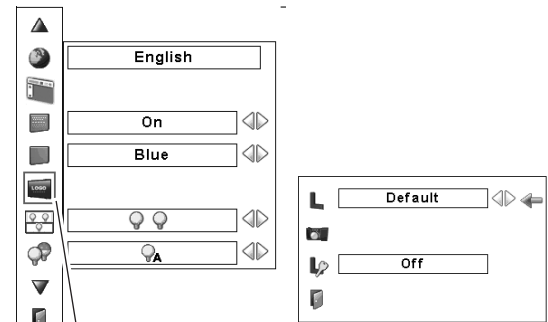

Set the red frame pointer to the item and press the SELECT button.

**Capture**

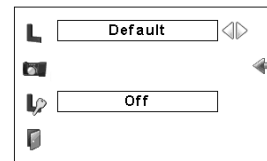

Set the pointer (red arrow) to the item and press the SELECT button.

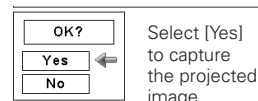

Select [Yes] to capture the projected image.

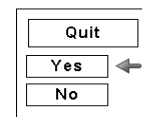

Select [Yes] to stop capturing.



**Logo PIN code lock**

This function prevents an unauthorized person from changing the screen logo.

- Off . . . . The screen logo can be changed freely from the Logo Menu.
- On . . . . The screen logo cannot be changed without a Logo PIN code.

If you want to change the Logo PIN code lock setting, press the SELECT button and the Logo PIN code dialog box appears. Enter a Logo PIN code by following the steps below. The initial Logo PIN code is set to "4321" at the factory.

**Enter a Logo PIN code**

Use the Point ▲▼ buttons on the side control or on the remote control to enter a number. Press the Point ► button to fix the number and move the red frame pointer to the next box. The number changes to "\*" Repeat this step to complete entering a four-digit number. After entering the four-digit number, move the pointer to "Set." Press the SELECT button so that you can change the Logo PIN code lock setting.

If you fixed an incorrect number, use the Point ◀ button to move the pointer to the number you want to correct, and then enter the correct number.

If you entered an incorrect Logo PIN code, "Logo PIN code" and the number (\*\*\*\*) will turn red for a moment. Enter the correct PIN code all over again.

**Change the Logo PIN code lock setting**

Use the Point ◀► buttons to switch On/Off, and then press the Point ▼ button to move the pointer to "Quit." Press the SELECT button to close the dialog box.

**Change the Logo PIN code**

Logo PIN code can be changed to your desired four-digit number. Press the Point ▼ button to select "Logo PIN code change" and then press the SELECT button. The New Logo PIN code input dialog box appears. Set a new Logo PIN code.

Be sure to note the new Logo PIN code and keep it on hand. If you lost the number, you could no longer change the Logo PIN code setting. For details on PIN code setting, refer to "PIN code lock" on pages 53–54.

**Logo PIN Code Lock**

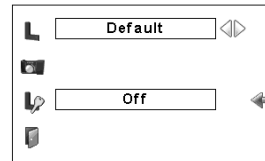

**Enter a Logo PIN code**

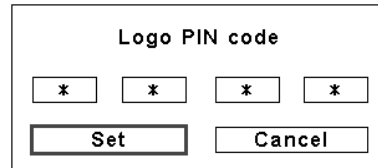

After a correct Logo PIN code is entered, the following dialog box appears.

**Change the Logo PIN code lock setting**



Use the Point ◀► buttons to switch On/Off,

**Change the Logo PIN code**

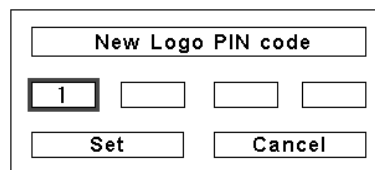

**CAUTION:**  
**WHEN YOU HAVE CHANGED THE LOGO PIN CODE, WRITE DOWN THE NEW PIN CODE IN COLUMN OF THE LOGO PIN CODE NO. MEMO ON PAGE 80, AND KEEP IT SECURELY. SHOULD THE LOGO PIN CODE BE LOST OR FORGOTTEN, THE LOGO PIN CODE SETTING CAN NO LONGER BE CHANGED.**



**Lamp mode**

This Projector is equipped with 2 Projection Lamps and the number of using lamps can be switched to 2 lamps or 1 lamp. Using 1 lamp maintains the life of Projection Lamps.

To change over Lamp Mode

Set "2 lamps mode" or "1 lamp mode" by pressing the Point ◀▶ buttons. When the Lamp Mode is switched from "2 lamps mode" to "1 lamp mode", the image becomes a little darker. When the Lamp Mode is switched from "1 lamp mode" to "2 lamps mode", the image becomes brighter gradually.

✓ **Note:**

- When neither of the two lamps is lighted, the projector will shutdown automatically.
- When either of the two lamps does not light up, the LAMP 1/2 REPLACE indicator blinks orange and the projector will light the other automatically.
- After changing the Lamp Mode, it cannot be switched again for 90 seconds.



**Lamp control**

This function allows you to change the brightness of the screen.

- Auto . . . . . Brightness according to the input signal.
- Normal . . . Normal brightness.
- Eco . . . . . Lower brightness. Lower brightness reduces the lamp power consumption and extends the lamp life.



**Filter control**

You can replace the filter with this function. Press the SELECT button at Filter control to display a confirmation box. To replace, press the SELECT button at "YES" and the electrically operated filter starts to scroll.

You can also replace the filter by using the remote control (p. 30).

✓ **Note:**

- Filter replacement icon and "Please wait..." message appear on the screen when the filter is being scrolled.
- The filter cannot be rewind.
- When the filter is replaced, the total accumulated time of the filter use is automatically set to 0.

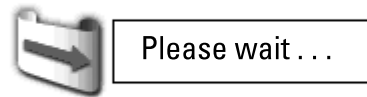

**Fan control**

Choose the running speed of cooling fans from the following options.

- Normal..... Normal speed.
- Max ..... Faster than the normal speed.

 **Remote control**

The eight different remote control codes (Code 1–Code 8) are assigned to the projector; the factory-set, initial code (Code 1) and the other seven codes (Code 2 to Code 8).

The same code should be set on both the projector and the remote control. For example, operating the projector in “Code 7”; the remote control code also must be switched to “Code 7”.

**To change the code for the projector:**

Select a remote control code in this Setting Menu.

**To change the code for the remote control:**

Check the Reset Switch to "Use position" in the compartment lid on the back of the remote control.

And then while holding down the MENU button, press and release the IMAGE ADJ. button the number of corresponding times you would like to set the number of the remote control code for the projector. (See page 16)

**To reset the code for the remote control:**

Slide the Reset Switch to "Reset position" in the compartment lid on back of the remote control.

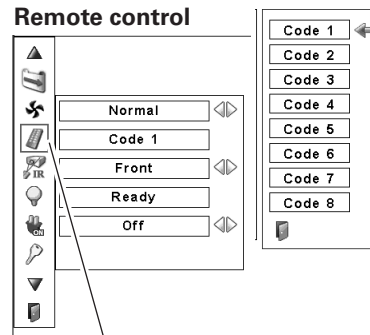

When pressing the SELECT button at Remote control, the Remote control code menu appears.

 **RC sensor**

Select a location of the infrared remote receiver of the remote control. See “Remote Control Receivers and Operating Range” on page 15 for details.

- Both..... Activate both the front and back receiver.
- Front..... Activate only the front receiver.
- Back..... Activate only the back receiver.

 **Power management**

For reducing power consumption as well as maintaining the lamp life, the Power management function turns off the projection lamp when the projector is not used for a certain period.

If the input signal is interrupted and no button is pressed for more than 30 seconds, the timer display with “No signal” appears. It starts the countdown until the lamp is turned off. The countdown time can be set between 1 and 30 minutes.

Use the Point ◀▶ buttons to set the countdown timer.

Select one of the following options:

- Ready . . . . . When the lamp has been fully cooled down, the READY indicator starts blinking. In this condition, the projection lamp is turned on if the input signal is reconnected or any button on the side control or remote control is pressed .
- Shutdown . . . . . When the lamp has been fully cooled down, the power is turned off.
- Off . . . . . Power Management function is off.

**✓ Note:**

- Factory default is “Ready: 5 min.”
- When the shutter is closed while the Power management function is working, the Power management function is released.

**Power management**



Time left before the lamp is off

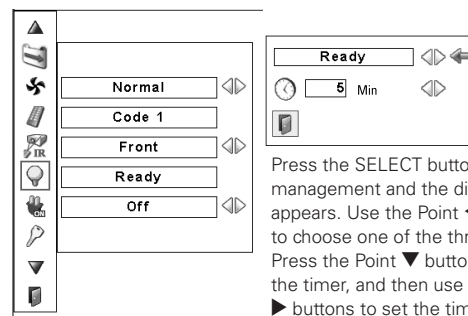

Press the SELECT button at Power management and the dialog box appears. Use the Point ◀▶ buttons to choose one of the three options. Press the Point ▼ button to select the timer, and then use the Point ◀▶ buttons to set the timer.



**On start**

When this function is set to “On,” the projector will be automatically turned on just by connecting the AC power cord to the wall outlet.

**✓ Note:**

- Make sure that the MAIN ON / OFF switch is ON, otherwise the On start function does not work.
- Be sure to turn off the projector properly (See “Turning Off the Projector” on page 24). If the projector is turned off in the incorrect sequence, the On start function does not work properly.



**Security**



**Key lock**

This function locks the side control and remote control buttons to prevent operation by unauthorized persons.

. . . . . Unlocked.

. . . . . Lock the side control buttons.  
To unlock, use the remote control.

. . . . . Lock the remote control buttons.  
To unlock, use the side control.

If the side control accidentally becomes locked and you do not have the remote control nearby and unable to operate the projector, contact the service center.



**PIN code lock**

This function prevents the projector from being operated by unauthorized persons and provides the following setting options for security.

- Off . . . . . Unlocked.
- On1 . . . . . Enter the PIN code every time turning on the projector.
- On2 . . . . . Enter the PIN code to operate the projector once the Main On/Off Switch is pressed to Off or the power cord is unplugged ; as long as the AC power cord is connected and the Main On/Off Switch is pressed to ON, the projector can be operated without a PIN code.

Whenever you change the PIN code lock setting or the PIN code (the four-digit number), you are required to enter the PIN code. “1234” is set as the initial PIN code at the factory.

If you want to change the PIN code lock setting, press the SELECT button and the PIN code dialog box appears. Enter a PIN code by following the steps on the next page.

**Security**

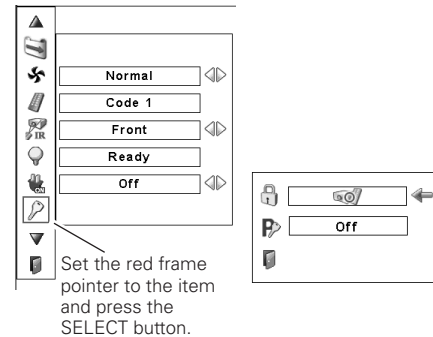

**Key lock**

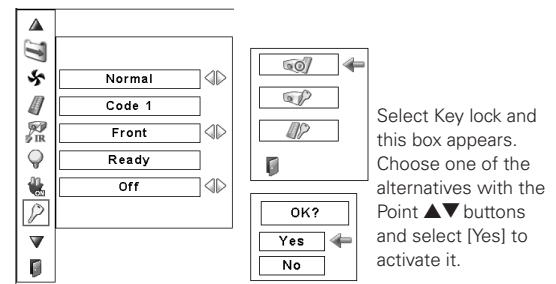

**PIN code lock**

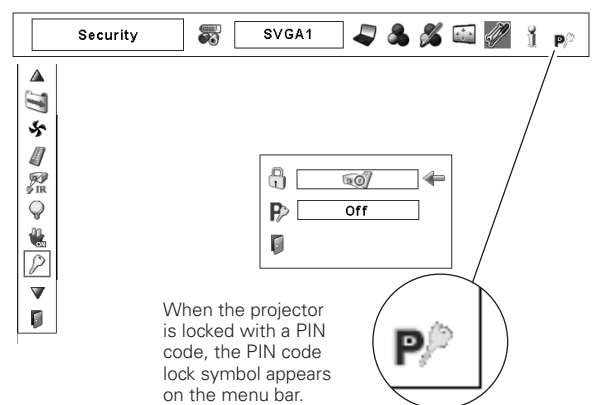

**Enter a PIN code**

Use the Point ▲▼ buttons on the side control or on the remote control to enter a number. Press the Point ► button to fix the number and move the red frame pointer to the next box. The number changes to “\*.” Repeat this step to complete entering a four-digit number. After entering the four-digit number, move the pointer to “Set.” Press the SELECT button so that you can change the PIN code lock setting .

If you fixed an incorrect number, use the Point ◀ button to move the pointer to the number you want to correct, and then enter the correct number.

If you entered an incorrect PIN code, “PIN code” and the number (\*\*\*\*) will turn red for a moment. Enter the correct PIN code all over again.

**Change the PIN Code Lock setting**

Use the Point ◀► button to select Off, On1, or On2 and then move the pointer to “Quit” with the Point ▼ button. Press the SELECT button to close the dialog box.

**Change the PIN Code**

The PIN code can be changed to your desired four-digit number. Press the Point ▼ buttons to select “PIN code change” and press the SELECT button. The New PIN code input dialog box appears. Set a new PIN code.

**CAUTION:**  
**WHEN YOU HAVE CHANGED THE PIN CODE, WRITE DOWN A NEW PIN CODE IN COLUMN OF THE PIN CODE NO. MEMO ON PAGE 80, AND KEEP IT SECURELY. IF YOU FORGET YOUR PIN CODE, THE PROJECTOR CAN NO LONGER BE STARTED.**



**Projector ID**

This feature allows users to set serial communication configuration (Projector ID) when several projectors are connected via the RS-232C terminal (serial port) of the projector.

Use the Point ◀► buttons to adjust the Projector ID.

- Projector ID ... 1 - 999. (Factory default setting : Projector ID 1)

**Enter a PIN code**

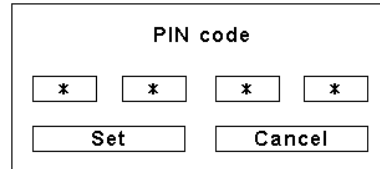

After a correct Logo PIN code is entered, the following dialog box appears.

**Change the PIN code lock setting**



Use the Point ◀► buttons to switch between the options.

**Change the PIN code**

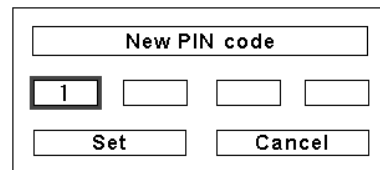





**Shutter**

Shutter function is available to block out light to the screen, so that the screen can be used for the other presenters.

**Protection**

Prohibits the shutter operation from the remote control and the projector's side control.

- Remote control    Selecting "On" prohibits the shutter operation from the remote control.
- Projector . . .    Selecting "On" prohibits the shutter operation from the side control.

It is possible to prohibit the shutter operation from both of the remote control and the side control.

**Management**

The Shutter Management function turns off the projection lamp when the projector is left with the shutter closed and the set time has passed away. The count-down time can be set between 5 and 180 minutes. When the count-down time has elapsed, the shutter will be opened up automatically and the lamp will be turned off to cool itself down. The SHUTTER indicator is blinking blue during this cooling-off period. When the lamp has been fully cooled down, the READY indicator turns green lighting and the SHUTTER indicator keeps blinking. Should the ON / STAND-BY button be pressed in this condition, the projection lamp will be turned on and the SHUTTER indicator turns off.

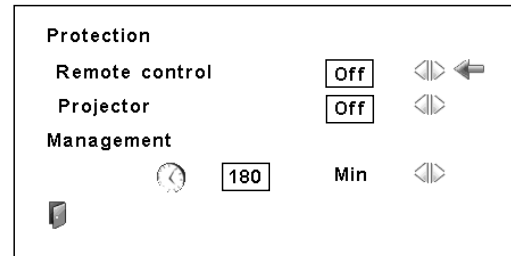

**✓ Note:**

- The Factory default value is set to 180 minutes for the count down time.
- The Shutter Management function cannot be halted.



**Lamp counter**

This function is used to reset the lamp counter.

When the lamp life reaches a recommended lamp replacement time, the time shown in the dialog box turns red and the Lamp replacement icon appears on the screen, indicating that the end of lamp life is approaching.

When replacing the projection lamp, reset the lamp counter. See "Resetting the Lamp Counter" on page 62.

**✓ Note:**

- The Lamp replacement icon will not appear when the Display function is set to "Off" (p.48), or during "Freeze" (p.29).



This icon appears on the screen when the end of lamp life is approaching.

**✓ Note:**

- This icon also appears at turning on and selecting input source.

 **Filter counter**

This function is used to set a time for the filter replacement.

Use the Point ▲▼ buttons to move the red frame pointer to Filter counter and then press the SELECT button. A dialog box appears showing the Used time option and the Scrolls remaining option.

- Used Time . . . . . Show the total accumulated time of the filter use, timer setting option and the Reset options. When the projector reaches a time set in the timer setting, the Filter replacement icon (Fig. 1) appears on the screen and the total accumulated time turns red, indicating that the filter replacement is necessary. If the filter is out of scroll and the projector reaches a time set in the timer setting, Fig. 2 appears on the screen, indicating that the filter cartridge replacement is necessary.
- Scrolls remaining . . . Show the scroll counter and the Reset options. When the filter scroll is counted down to 1 (Scroll counter on the screen is showing "0 scroll(s)", the last scroll icon (Fig. 3) appears on the screen. When the filter scroll is counted down to 0, the Filter cartridge replacement icon (Fig. 4) appears on the screen and the WARNING FILTER indicator lights orange, indicating that the filter cartridge replacement is necessary.

To set a timer, press the SELECT button on Used time option. Move the red arrow pointer to the timer setting option and use the Point ◀▶ buttons to select from (Off/ 400H/700H/1000H) depending on the use environment.

When replacing the Filter cartridge, reset the Filter counter and the Scroll counter (p.59).

- ✓ **Note:**
- Do not reset the Filter counter and the Scroll counter without replacing the Filter cartridge. Be sure to reset the Filter counter and the Scroll counter only after replacing the Filter cartridge.
  - Timer setting notifies that the filter needs replacement. To replace the filter, use the filter control function (p.51).

 **Test pattern**

Various test pattern are available for use when setting up the projector.

 **Factory default**

This function returns all setting values except for the user logo, PIN code lock, Logo PIN code lock, lamp counter, filter counter and filter timer to the factory default settings.

 **Quit**

Exit the Setting Menu.

**Filter counter**

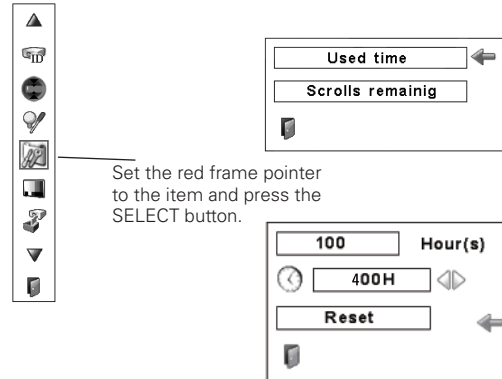

Set the red frame pointer to the item and press the SELECT button.

Use the Point ◀▶ buttons to set the timer. Select from (Off/ 400H/700H/1000H) depending on the use environment



Filter replacement icon appears on the screen at a set time.

**Fig.1** Filter replacement icon



**Fig.2**



Last scroll icon appears on the screen when the filter is down to the last scroll.

**Fig.3** Last scroll icon



Filter cartridge replacement icon appears on the screen when the filter scroll is counted down to 0 scroll.

**Fig.4** Filter cartridge replacement icon

- ✓ **Note:**
- Fig.1, Fig. 2, Fig. 3 or Fig. 4 will appear at turning on and selecting input source.
  - Fig.1, Fig. 2, Fig. 3 or Fig. 4 will not appear when the Display function is set to "Off" (p.48), or during "Freeze" (p.29).

- ✓ **Note:**
- Zoom, Focus, Lens-shift and Shutter functions are operative while the test pattern is being displayed.
  - If you close the shutter while displaying a test pattern and open it again, the test pattern display will disappear.

## Filter Instructions

Filter prevents dust from accumulating on the optical elements inside the projector. Should the filter becomes clogged with dust particles, it will reduce cooling fans' effectiveness and may result in internal heat buildup and adversely affect the life of the projector. This projector has an electrically operated filter which helps you to replace the filter easily. The projector monitors the condition of the filter at all time and replaces a filter with a new one automatically when it detects the clogging.

If the projector reaches a time set in the timer setting (p. 56), a Filter replacement icon (Fig.1) appears on the screen and the WARNING FILTER indicator on the top panel lights up (p.74). When you see this icon, replace the filter as soon as possible (pp.30, 51). If the filter is out of scroll and the projector reaches a time set in the timer setting, Fig. 2 appears on the screen, indicating that the filter cartridge replacement is necessary.

When the filter scroll is counted down to 1, the Last scroll icon (Fig.3) appears on the screen, indicating that there is one scroll left in the filter cartridge (p.56).

If the projector detects that the filter is clogged and no scroll is left in the filter cartridge, a Filter cartridge replacement icon (Fig. 4) appears on the screen and the WARNING FILTER indicator on the top panel lights up (p.74). When you see this icon, replace the filter cartridge (p.58) and reset the Filter counter (p.59) and the Scroll counter (p.59).

When the filter is being scrolled by the remote control (p.30) or the Filter control function in the setting menu (p.51), a Filter replacement icon and "Please wait..." message (Fig.5) appear on the screen and the WARNING FILTER indicator blinks slow (approx. 2 seconds ON, 2 seconds OFF) (p.72).

The WARNING FILTER indicator blinks fast when the projector detects an abnormal condition, the filter cartridge is not installed properly, or the filter scroll is not working properly (p.74).



**Fig.1** Filter replacement icon



**Fig.2**



**Fig.3** Last scroll icon



**Fig.4** Filter cartridge replacement icon



Please wait . . .

**Fig.5** Filter replacement icon and "Please wait..." message.

**✓ Note:**

- Fig.1, Fig.2, Fig.3 or Fig. 4 will not appear when the Display function is set to "Off" (p.48), or during "Freeze" (p.29).
- The filter cannot be rewind.
- The filter can be scrolled 9 times since the filter cartridge has 10 scrolls.
- The filter cartridge is disposable. Do not clean and reuse the filter cartridge.
- Do not expose the filter cartridge to water or liquid, or it may cause a breakdown.
- Replace the filter cartridge after all the scroll is used up. If you replace the filter cartridge when there are some scrolls left in the filter cartridge, the filter counter and the scroll counter do not recognize the correct number of remaining scrolls and the reset function cannot work properly. It may cause a breakdown.
- The used part of the filter can be seen on the edge of the Filter cartridge after scrolling the filter, but there is no problem for the use of the projector.
- Do not use the filter cartridge with other projector. The filter counter and the scroll counter do not recognize the correct number of remaining scrolls of the used filter cartridge and the reset function cannot work properly. It may cause a breakdown.
- Make sure that the projection lamps are turned off when you are replacing the filter cartridge. If you replace the filter cartridge when the projection lamps are turned on, the projector will be shut down automatically for safety purposes.
- Do not forget to reset the filter counter and the scroll counter in the setting menu after replacing the filter cartridge. If you forget to reset the filter counter and the scroll counter, the projector cannot recognize the correct number of remaining scrolls and it may cause a breakdown.
- When the projector is kept used for 3 minutes without getting the filter cartridge replaced after the Fig.4 appears on the screen, the projector is turned off automatically to prevent the damage of optical components.

## Replacing the Filter Cartridge

- 1** Turn off the projector, press the Main On/Off Switch to Off and unplug the AC power cord from the AC outlet.
- 2** First, clean up the dust on the projector and around the air vents.
- 3** Slide and open the Filter cover. (See the right figure.)
- 4** Pull out the filter cartridge by holding the finger grip.
- 5** Put the new one back into the position and close the filter cover. Make sure that the filter cartridge is properly and fully inserted.
- 6** Connect the AC power cord to the projector and turn on the projector.
- 7** **Reset the filter counter and the scroll counter** (p.59).

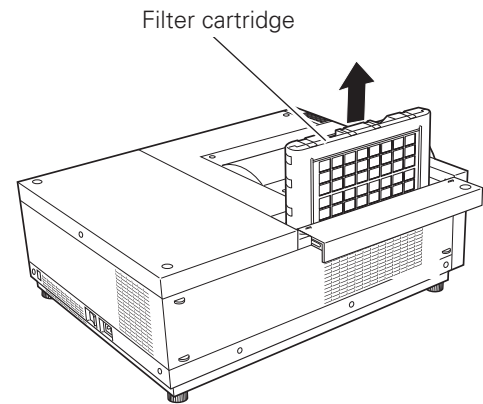
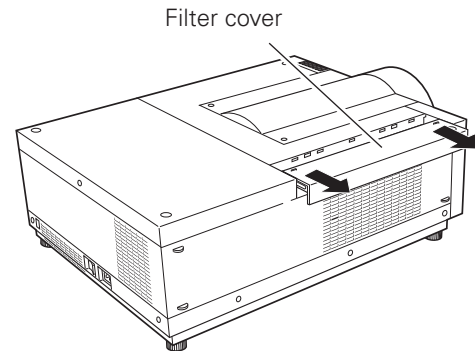

### **CAUTION**

Make sure the filter cartridge is inserted in the projector. If the filter cartridge is not inserted, the projector cannot be turned on.  
Do not put anything into the air vents. Doing so may result in malfunction of the projector.

### **RECOMMENDATION**

**We recommend avoiding dusty/smoky environments when operating the projector. Usage in these environments may cause a poor image quality.**

When using the projector under dusty or smoky conditions, dust may accumulate on a lens, liquid crystal panels, or optical elements inside the projector. Such condition may degrade the quality of the projected image.

When the symptoms above are noticed, contact your authorized dealer or service center for proper cleaning.

### **ORDER REPLACEMENT FILTER CARTRIDGE**

Replacement filter cartridge can be ordered through your dealer. When ordering, give the following information to the dealer.

- **Model No. of your projector**  
**LX1200**
- **Replacement Filter Cartridge**  
**Service Parts Code: 003-002003-01**

### Resetting the Filter Counter

Be sure to reset the Filter counter after replacing the filter cartridge.

- 1 Press the MENU button to display the On-Screen Menu. Use the Point ◀▶ buttons to move the red frame pointer to the Setting Menu icon.
- 2 Use the Point ▲▼ buttons to move the red frame pointer to Filter counter and then press the SELECT button. A dialog box appears showing the Used time option and the Scrolls remaining option. Use the Point ▲▼ buttons to select Used time.
- 3 Used time shows the total accumulated time of the filter use, a timer setting option, and the Reset option. Select Reset and the "Filter counter Reset?" appears. Select [Yes] to continue.
- 4 Another confirmation dialog box appears, select [Yes] to reset the Filter counter.

#### Filter counter

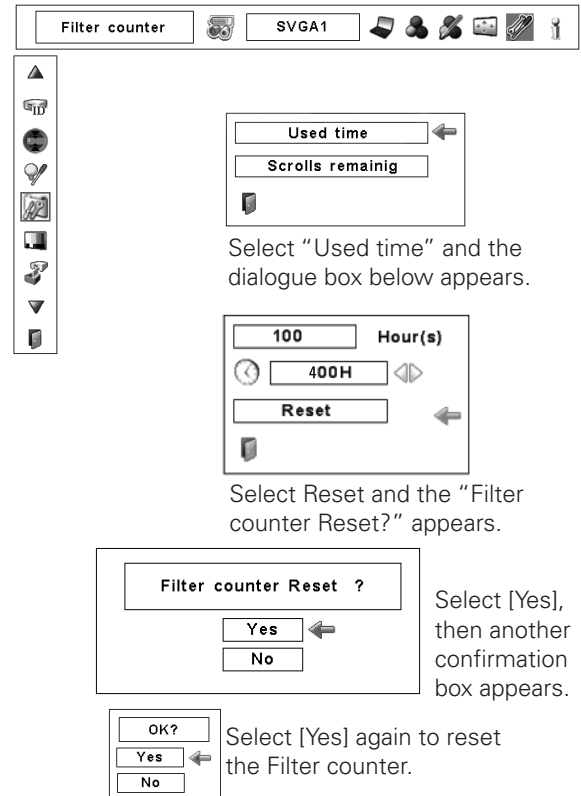

Select "Used time" and the dialogue box below appears.

Select Reset and the "Filter counter Reset?" appears.

Select [Yes], then another confirmation box appears.

Select [Yes] again to reset the Filter counter.

### Resetting the Scroll Counter

Be sure to reset the Scroll counter after replacing the filter cartridge.

- 1 Press the MENU button to display the On-Screen Menu. Use the Point ◀▶ buttons to move the red frame pointer to the Setting Menu icon.
- 2 Use the Point ▲▼ buttons to move the red frame pointer to Filter counter and then press the SELECT button. A dialog box appears showing the Used time option and the Scrolls remaining option. Use the Point ▲▼ buttons to select Scroll(s) remaining.
- 3 Scroll(s) remaining shows the number of the remaining scrolls and the Reset option. Select Reset and the "Scroll counter Reset?" appears. Select [Yes] to continue.
- 4 Another confirmation dialog box appears, select [Yes] to reset the Scroll counter.

#### Scroll counter

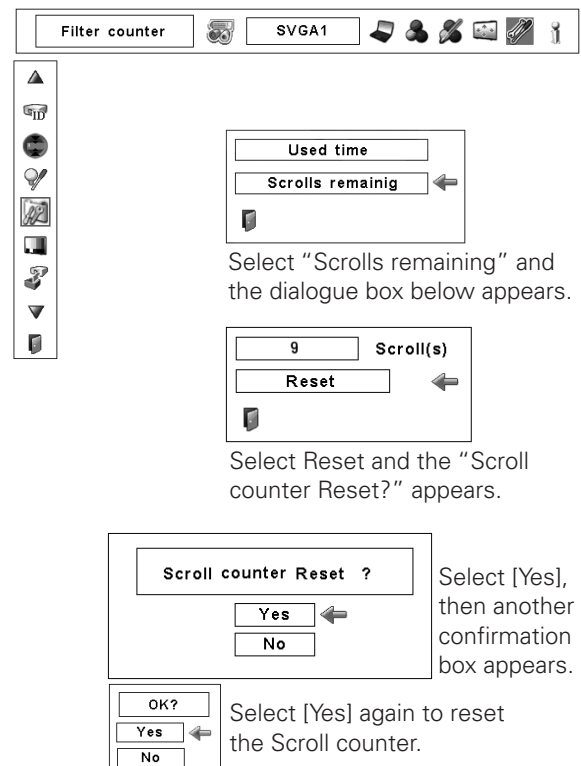

Select "Scrolls remaining" and the dialogue box below appears.

Select Reset and the "Scroll counter Reset?" appears.

Select [Yes], then another confirmation box appears.

Select [Yes] again to reset the Scroll counter.

✓ **Note:**

•While the scroll counter reset is in progress, "Please wait..." message appears on the screen, the cooling fans operate and the filter cartridge is adjusted.

### Lamp Management

This Projector is equipped with 2 Projection Lamps to ensure brighter image and those lamps are controlled by the Lamp Management Function. The Lamp Management Function detects the status of lamps and shows the status on screen or on the LAMP 1/2 REPLACE indicators. This function also automatically controls the Lamp Mode when any of lamps is out for the end of life or malfunctions.

LAMP 1/2 REPLACE INDICATORS

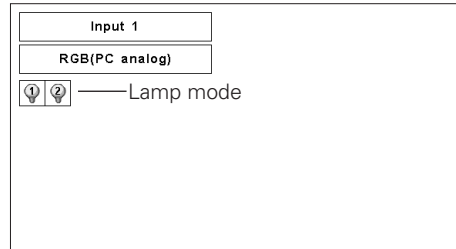
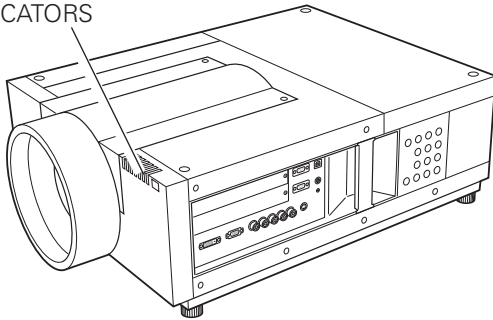

### Lamp 1/2 Replace Indicators

The LAMP 1/2 REPLACE indicators light orange when any of Projection Lamps is nearing its end, and flash when any of them becomes out. Check the number of lamp on the Lamp Status Display or the LAMP 1/2 REPLACE indicators and replace the lamp.

### Lamp Status Display

The Lamp Status Display appears on screen when the projector is turned on or the input position (input 1, input 2, Input 3 or input 4) is switched. This shows the status of each lamp as; ON, OFF, NEAR END, or OUT. Refer to the following for each status.

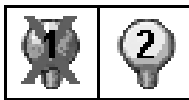

LAMP STATUS DISPLAY

**Yellow Lamp** ----- Projection Lamp lights normally.

**Dim Lamp** ----- Projection Lamp is turned off.

**Red Lamp** ----- Projection Lamp is nearing its end. When the image becomes darker or the color becomes unnatural, replace lamp. (LAMP 1/2 REPLACE indicator lights orange.)

**X Mark on Lamp** ----- (LAMP 1/2 REPLACE indicator flashes orange.) Projection lamp is defective or fails to be turned on. Restart the projector on, and make sure lamp is on. If this mark still appears, replace lamp corresponding with number marked X.

### Lamp Mode Changeover

The Lamp Management Function automatically changes the lighting lamp (Lamp Mode) by detecting the status of lamp. When either of the 2 lamps is out, the projector operates with 1 lamp. The Lamp Mode can be switched to 2 lamps or 1 lamp manually. Refer to the SETTING section on page 51.

2 LAMP MODE



1 LAMP MODE

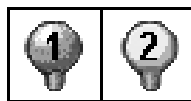

When Lamp 1 is burnt out.



When Lamp 2 is burnt out.



## Lamp Replacement

When the projection lamp of the projector reaches its end of life, the Lamp replacement icon appears on the screen and LAMP 1/2 REPLACE indicator lights orange. Replace the lamp with a new one promptly. The timing when the LAMP 1/2 REPLACE indicators should light is depending on the lamp mode.

### Indicators

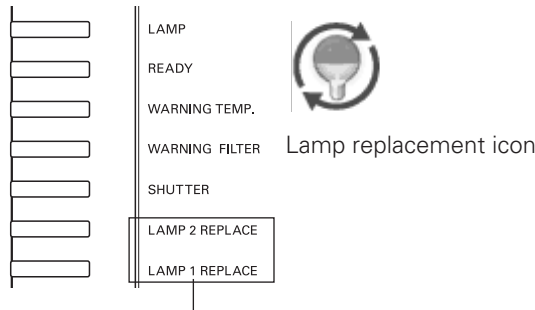

LAMP 1 / 2 REPLACE indicators

✓ **Note:**

- The Lamp replacement icon will not appear when the Display function is set to "Off" (p.48), or during "Freeze" (p.29).



**WARNING:**

TURN OFF THE UV LAMP BEFORE OPENING THE LAMP COVER.



Allow the projector to cool, for at least 45 minutes before you open Lamp Cover. The inside of the projector can become very hot.



**CAUTION**

For continued safety, replace with a lamp assembly of the same type.

Do not drop the lamp assembly or touch a glass bulb! The glass can shatter and may cause injury.

Follow these steps to replace the lamp.

- 1 Check the number of lamp to be replaced on the Lamp Status Display.
- 2 Turn off the projector, press the Main On/Off Switch to Off and unplug the AC power cord from the AC outlet. Let the projector cool for at least 45 minutes.
- 3 Loosen a screw on the Lamp Cover. Slide and open the Lamp Cover. (See the right figure.)
- 4 Loosen two screws and pull out the Lamp to be replaced by grasping handle.
- 5 Replace the Lamp with a new one and tighten two screws. Make sure the Lamp is set properly.
- 6 Put the Lamp Cover back and tighten a screw.
- 7 Connect the AC Power Cord to the projector and turn on the projector.
- 8 Reset the Lamp Replacement Counter. (Refer to section "Resetting the Lamp Counter" on page 62.)

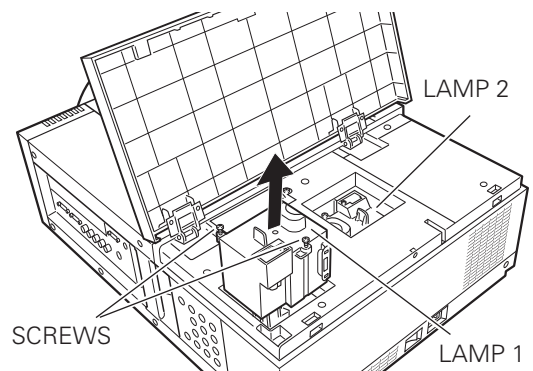
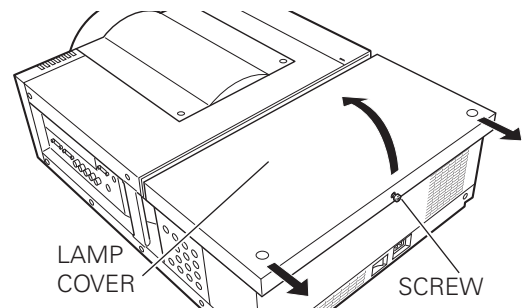

NOTE : Do not reset LAMP REPLACEMENT COUNTER when lamp is not replaced.

Make sure which number of lamp needs to be replaced on Lamp Status Display. Figure shows case of replacing LAMP 1.

**CAUTION : DO NOT OPERATE THE PROJECTOR WHILE ANY OF LAMPS IS REMOVED. IT MAY RESULT IN MALFUNCTIONS, FIRE HAZARD, OR OTHER ACCIDENTS.**

**NOTES ON LAMP REPLACEMENT**

To maintain quality of picture (better balance of color and brightness in entire screen), we recommend replacing both 2 lamps at a time.

## Resetting the Lamp Counter

Be sure to reset the Lamp counter after the lamp is replaced. When the Lamp counter is reset, the LAMP 1/2 REPLACE indicator stops lighting and the Lamp replacement icon disappears.

- 1 Press the MENU button to display the On-Screen Menu. Use the Point ◀▶ buttons to move the red frame pointer to the Setting Menu icon
- 2 Use the Point ▲▼ buttons to move the red frame pointer to Lamp counter and then press the SELECT button. A dialog box appears. Select a lamp and the "Lamp replacement counter Reset?" appears. Select [Yes] to continue.
- 3 Another confirmation dialog box appears and select [Yes] to reset the Lamp counter.

✓ **Note:**

- Do not reset the Lamp counter without replacing the lamp. Be sure to reset the Lamp counter only after replacing the lamp.

### Lamp counter

The screenshot shows the 'Lamp counter' menu. At the top, it says 'Lamp counter' and 'SVGA1'. Below that, there are two rows of lamp information: 'Lamp1 110 Hour(s)' and 'Lamp2 220 Hour(s)'. A dialog box titled 'Lamp replacement counter Reset?' is displayed with 'Yes' and 'No' buttons. Below that, another dialog box titled 'OK?' is shown with 'Yes' and 'No' buttons. Arrows indicate the selection path.

### ORDER REPLACEMENT LAMP

Replacement Lamp can be ordered through your dealer. When ordering a Projection Lamp, give the following information to the dealer.

- **Model No. of your projector** : **LX1200**
- **Replacement Lamp Type No.** : **003-120479-01**  
(Service Parts No. 610 341 9497)





## LAMP HANDLING PRECAUTIONS

This projector uses a high-pressure lamp which must be handled carefully and properly. Improper handling may result in accidents, injury, or create a fire hazard.

- Lamp lifetime may differ from lamp to lamp and according to the environment of use. There is no guarantee of the same lifetime for each lamp. Some lamps may fail or terminate their lifetime in a shorter period of time than other similar lamps.
- If the projector indicates that the lamp should be replaced, i.e., if the LAMP 1/2 REPLACE indicators light up, replace the lamp with a new one IMMEDIATELY after the projector has cooled down. (Follow carefully the instructions in the Lamp Replacement section of this manual.) Continuous use of the lamp with the LAMP 1/2 REPLACE indicators lighted may increase the risk of lamp explosion.
- Lamp may explode as a result of vibration, shock or degradation as a result of hours of use as its lifetime draws to an end. Risk of explosion may differ according to the environment or conditions in which the projector and lamp are being used.

### **IF A LAMP EXPLODES, THE FOLLOWING SAFETY PRECAUTIONS SHOULD BE TAKEN.**

If a lamp explodes, disconnect the projector's AC plug from the AC outlet immediately. Contact an authorized service center for a checkup of the unit and replacement of the lamp. Additionally, check carefully to ensure that there are no broken shards or pieces of glass around the projector or coming out from the cooling air circulation holes. Any broken shards found should be cleaned up carefully. No one should check the inside of the projector except those who are authorized trained technicians and who are familiar with projector service. Inappropriate attempts to service the unit by anyone, especially those who are not appropriately trained to do so, may result in an accident or injury caused by pieces of broken glass.

## Cleaning the Projection Lens

Turn off the projector, press the Main On/Off Switch to Off and unplug the AC power cord from the AC outlet before cleaning.

Gently wipe the projection lens with a cleaning cloth that contains a small amount of non-abrasive camera lens cleaner, or use a lens cleaning paper or commercially available air blower to clean the lens.

Avoid using an excessive amount of cleaner. Abrasive cleaners, solvents, or other harsh chemicals might scratch the surface of the lens.

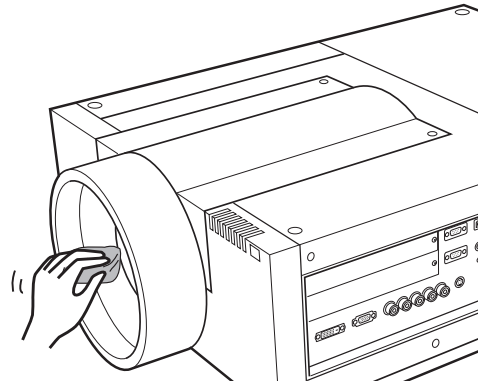

## Cleaning the Projector Cabinet

Turn off the projector, press the Main On/Off Switch to Off and unplug the AC power cord from the AC outlet before cleaning.

Gently wipe the projector body with a soft dry cleaning cloth. When the cabinet is heavily soiled, use a small amount of mild detergent and finish with a soft dry cleaning cloth. Avoid using an excessive amount of cleaner. Abrasive cleaners, solvents, or other harsh chemicals might scratch the surface of the cabinet.

When the projector is not in use, put the projector in an appropriate carrying case or cover to protect it from dust and scratches.

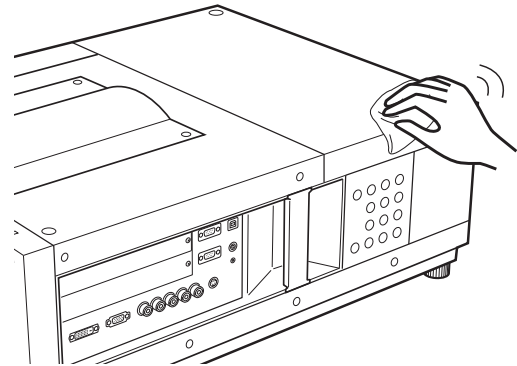

### **CAUTION**

Do not use any flammable solvents or air sprays on the projector and in its vicinity. The explosion or fire hazard may occur even after the AC power cord is unplugged because the temperature inside the projector is extremely high due to the lamps. In addition, there is a risk that the internal parts may be damaged not only by the flammable air spray but also by the cold air.

**Warning Indicators**

The WARNING indicators show the state of the function which protects the projector. Check the state of the WARNING TEMP. indicator and the LAMP indicator to take proper maintenance.

**The projector is shut down and the WARNING TEMP. indicator is blinking red.**

When the temperature inside the projector reaches a certain level, the projector will be automatically shut down to protect the inside of the projector. The LAMP indicator turns red brighter and the WARNING TEMP. indicator blinks while the projector is being cooled down. When the projector has cooled down enough (to its normal operating temperature), it can be turned on again by pressing the ON/STAND-BY button.

**✓ Note:**

- The WARNING TEMP. indicator continues to blink even after the temperature inside the projector returns to normal. When the projector is turned on again, the WARNING TEMP. indicator stops blinking.

**Indicators**

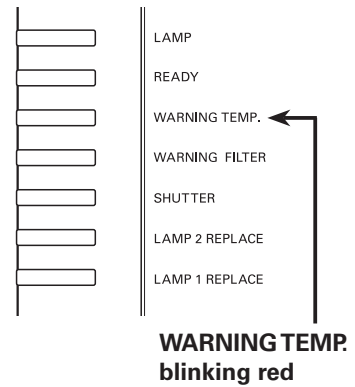

**Then check the matters below:**

- Did you provide appropriate space for the projector to be ventilated? Check the installing condition to see if the air vents of the projector are not blocked.
- Has the projector been installed near an Air-Conditioning/ Heating Duct or Vent? Move the installation of the projector away from the duct or vent.
- Is the filter clean? Replace the filter with a new one.

**The projector is shut down; and the LAMP indicator is lighting and other indicators are blinking.**

When the projector detects an abnormal condition, it will be automatically shut down to protect the inside of the projector and the LAMP indicator lights on and other indicators blink. In this case, unplug the AC power cord and plug it, and then turn on the projector once again to verify operation. If the projector cannot be turned on and these indicators are still lighting and blinking, unplug the AC power cord and contact the service center.



**CAUTION**

DO NOT LEAVE THE PROJECTOR WITH THE AC POWER CORD CONNECTED UNDER AN ABNORMAL CONDITION. IT MAY RESULT IN FIRE OR ELECTRIC SHOCK.

**Indicators**

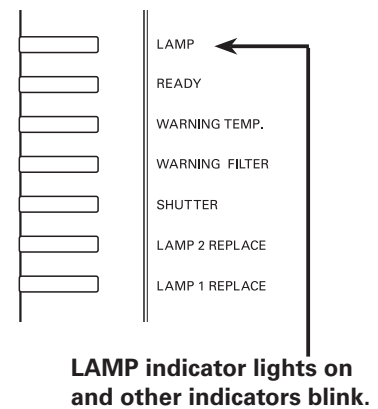





## Troubleshooting

Before calling your dealer or service center for assistance, check the items below once again.

1. Make sure you have properly connected the projector to peripheral equipment as described on pages 20–21.
2. Check the cable connection. Make sure that all computers, video equipment, and power cords are properly connected.
3. Make sure that all power is switched on.
4. If the projector still does not produce an image, restart your computer.
5. If an image still does not appear, disconnect the projector from your computer and check your computer monitor's display. A problem may be noticed with your graphics controller rather than with the projector. (When you reconnect the projector, be sure to turn the computer and monitor off before you turn on the projector. Turn on equipment in the order of the projector and computer.)
6. If a problem still persists, check the following solutions.

| <b>Problem:</b>  | <b>Solutions</b>   |
|--|--|
| <b>No power.</b>   | <ul style="list-style-type: none"> <li>–Plug the power cord of the projector into the AC outlet.</li> <li>–Turn the MAIN ON/OFF switch to ON.</li> <li>–Press the ON/STAND-BY Button to ON.</li> <li>–Make sure the READY Indicator lights.</li> <li>–Check the indicators. If the LAMP indicator lights and the other indicators blink, the projector cannot be turned on. (Refer to page 65.)</li> <li>–Check the projection lamp. (Refer to page 61.)</li> </ul>  |
| <b>PIN code dialog box appears at start-up.</b>  | <ul style="list-style-type: none"> <li>–PIN code lock is being set. Enter a PIN code; the “1234” or numbers you have set. (See pages 23, 53-54.)</li> </ul>  |
| <b>The initial display is not shown.</b>   | <ul style="list-style-type: none"> <li>–Make sure “Off ” or “Countdown Off” are not chosen at Display function. (See “SETTING” section on page 48.)</li> </ul>   |
| <b>The initial display is not same with the default one.</b>   | <ul style="list-style-type: none"> <li>–Make sure “User” or “Off” are not chosen at Logo select function. (See “SETTING” section on page 49.)</li> </ul>   |
| <b>When the projector is on and you press the input button, an icon other than the Lamp mode icon appears.</b> | <ul style="list-style-type: none"> <li>–That is the Filter warning icon. Refer to page 56.</li> </ul>  |
| <b>An icon other than Input mode or Lamp mode icon appears.</b>  | <ul style="list-style-type: none"> <li>–That is the Lamp replacement icon or the Filter warning icon. See pages 55-56.</li> </ul>  |
| <b>No image.</b>   | <ul style="list-style-type: none"> <li>–Check the connection between your computer or video equipment and the projector.</li> <li>–See if the input signal is correctly output from your computer. Some laptop computers may need to be changed the setting for monitor output when connected to the projector. See your computer's instruction manual for the setting.</li> <li>–It takes about 20 seconds to display an image after turning on the projector.</li> <li>–See if the selected system is corresponding with your computer or video equipment.</li> <li>–Select correct input source once again through menu operation. (See pages 31, 41-42.)</li> <li>–Make sure the temperature is not out of Operating Temperature (41°F–104°F [5°C–40°C]).</li> </ul> |

|  |   |
|--|---|
| <br><b>appears on the screen</b>  | <p>-The end of lamp life is approaching. Replace the lamp with a new one promptly. (See page 55.)</p>   |
| <br><br><b>appears on the screen</b> | <p>-The filter is out of scroll. Replace the filter cartridge with a new one promptly. (See pages 57-58.)</p>   |
| <p><b>The image is out of focus.</b></p>   | <p>-Adjust the focus of the projector.<br/>         -Check Projection Lens to see if it needs cleaning.<br/> <b>✓Note:</b> Moving the projector from a cool temperature location to a warm temperature location may result in moisture condensation on Projection Lens. In such cases, leave the projector OFF and wait until condensation evaporates.<br/>         -Projecting from excessive slant angle to the screen may cause keystone distortion and partial imperfect focus.</p>   |
| <p><b>The image is not bright enough.</b></p>  | <p>-Check if "Contrast" or "Brightness" are adjusted properly. (See page 45.)<br/>         -Check if "Image level" is selected properly. (See pages 38, 42.)<br/>         -Check the Lamp control function. ( See "SETTING" section on page 51.)<br/>         -Check the Lamp 1/2 replace indicators. If it lights, the end of lamp life is approaching. Replace the lamp with a new one promptly. (See page 61.)<br/>         -The image is darker when 1 lamp mode is selected, compared with 2 lamp mode. Check the lamp mode at SETTING section on page 51.</p> |
| <p><b>The color is strange.</b></p>  | <p>-Check the Input signal, color system, video system, or computer system mode.</p>  |
| <p><b>The image is Left/Right reversed.</b></p>  | <p>-Check the Ceiling / Rear function. (See pages 40, 44.)</p>  |
| <p><b>The image is Top/Bottom reversed.</b></p>  | <p>-Check the Ceiling function. (See pages 40, 44.)</p>   |
| <p><b>The image is distorted or runs off.</b></p>  | <p>-Check "PC Adjust" menu or " Screen" menu and adjust them.</p>   |
| <p><b>Auto PC adjustment function does not work.</b></p>   | <p>-Check the Input signal. Auto PC Adjustment function cannot work when 480p, 575p, 720p, 480i, 575i, 1035i, or 1080i is selected or when the digital signal is input into DVI terminal. (See page 35.)</p>  |
| <p><b>Some displays are not seen during the operation.</b></p>   | <p>-Check the Display function. (See page 48.)</p>  |
| <p><b>The setting does not remain after turning off power.</b></p>   | <p>-Make sure you selected "Store" after adjusting settings. Some settings cannot be stored if not registered with "Store".</p>   |
| <p><b>Power management function does not work.</b></p>   | <p>-Power management function cannot work while "Freeze" function is running or the shutter is closed.</p>  |
| <p><b>Image disappears automatically.</b></p>  | <p>-Check the power management function in the Setting. The power management is set to "On" at the factory.</p>   |
| <p><b>Capture function does not work.</b></p>  | <p>-Check the connection to see if there is signal.</p>   |
| <p><b>Some menus cannot be selected.</b></p>   | <p>-Each of the Video Input and Computer Input has a limit on selectable menus.</p>   |

|  |   |
|--|---|
| <p><b>The power is turned off automatically.</b></p>   | <p>–Power management function runs by initial setting. Check “SETTING” section on page 52.</p>  |
| <p><b>You cannot operate with the side control.</b></p>  | <p>–The side control is not available If the side control is locked at “Key lock” under “Security” of SETTING section. Please check “SETTING” section on page 53.</p>   |
| <p><b>The Remote Control does not work.</b></p>  | <p>–Check the batteries.<br/>                 –Check if the RC sensor is set properly. (See page 52.)<br/>                 –Make sure no obstruction is between the projector and remote control.<br/>                 –Make sure you are not too far from the projector when using the remote control. Maximum operating range is 16.4’ (5m).<br/>                 –Make sure that the remote control code conforms to the projector’s code. (See “SETTING” section on page 52.)<br/>                 –Make sure the reset switch in the compartment lid on back of the remote control is set to use position.<br/>                 –Unlock the Key lock function for the remote control. (See page 53.)<br/>                 –Wireless remote control does not work when the remote control cable is connected to the projector. (See page 15.)</p> |
| <p><b>Indicators blinks or lights.</b></p>   | <p>–Check the status of the projector with referring to “ INDICATORS AND PROJECTOR CONDITION” on pages 72-74.</p>   |
| <p><br/><b>appears on the screen</b></p> | <p>–Your operation is invalid. Operate correctly.</p>   |
| <p><b>Unable to unlock the Logo PIN code lock, Security key lock or Security PIN code lock.</b></p>                        | <p>–Contact the dealer where you purchased the projector or the service center.</p>   |
| <p><b>Forget the Logo PIN code or Security PIN code.</b></p>   | <p>–Contact the dealer where you purchased the projector or the service center.</p>   |

**WARNING:**

**High voltages are used to operate this projector. Do not attempt to open the cabinet.**

If problems still persist after following all operating instructions, contact the dealer where you purchased the projector or the service center. Specify the model number and explain about the problem. We will advise you how to obtain service.



This symbol on the nameplate means the product is Listed by Underwriters Laboratories Inc. It is designed and manufactured to meet rigid U.L. safety standards against risk of fire, casualty, and electrical hazards.



The CE Mark is a Directive conformity mark of the European Community (EC).

## Menu Tree

### Computer Input/Video Input

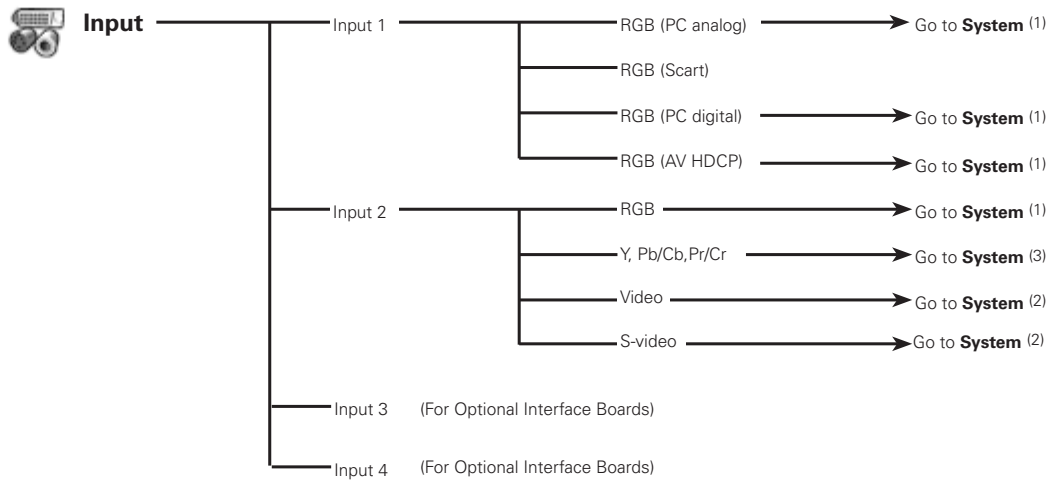

### Information

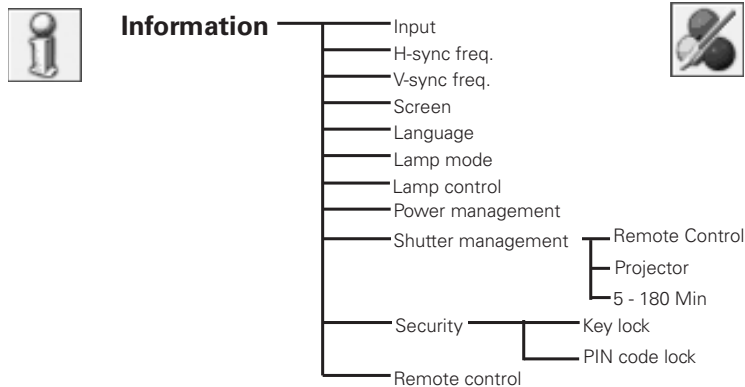

### Image Adjust

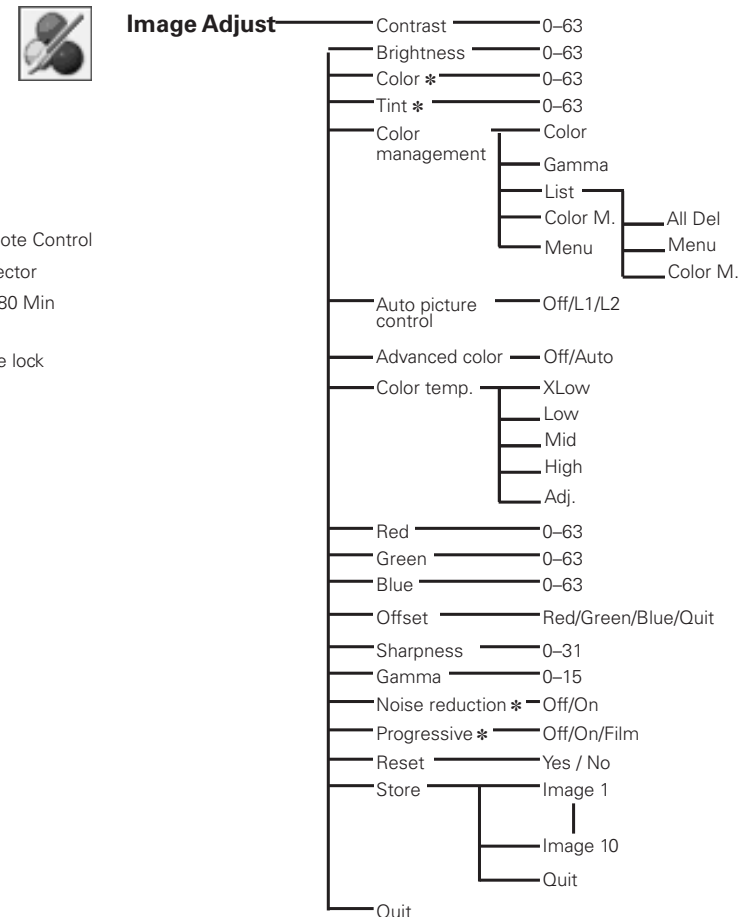

\* Displayed in grayout in the computer Input.

✓ **Note:**

•The Menu display varies depending on the input signal.

Computer Input

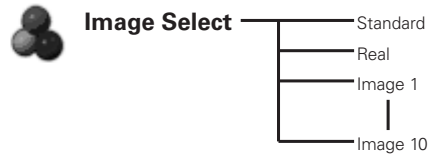
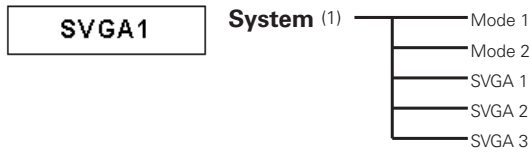

\* System displayed in the System Menu varies depending on the input signal.

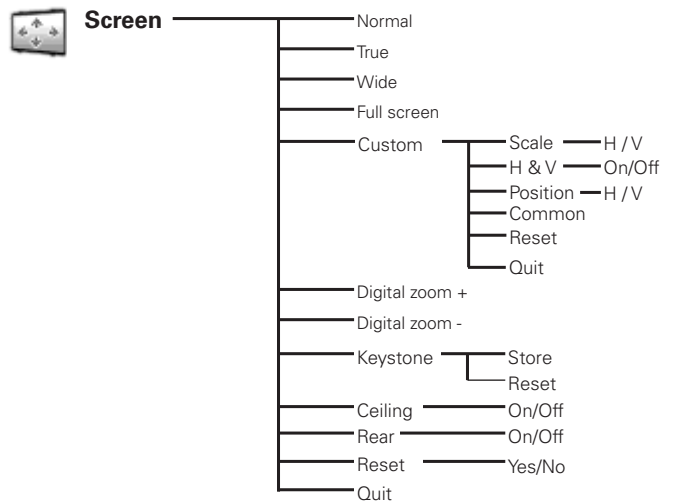
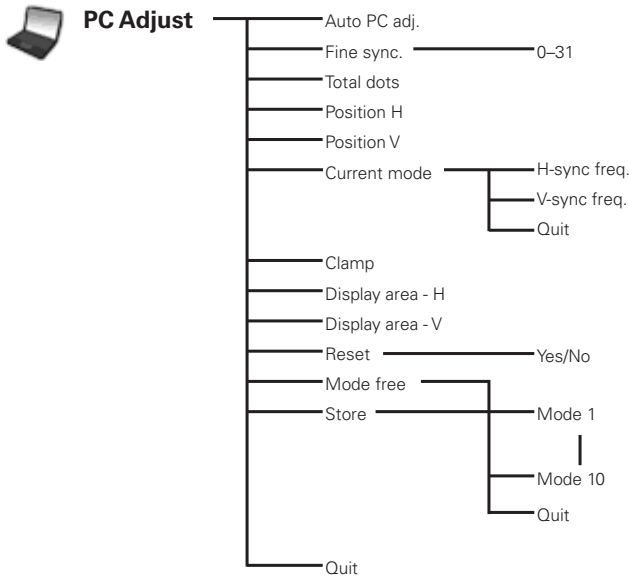

Video Input

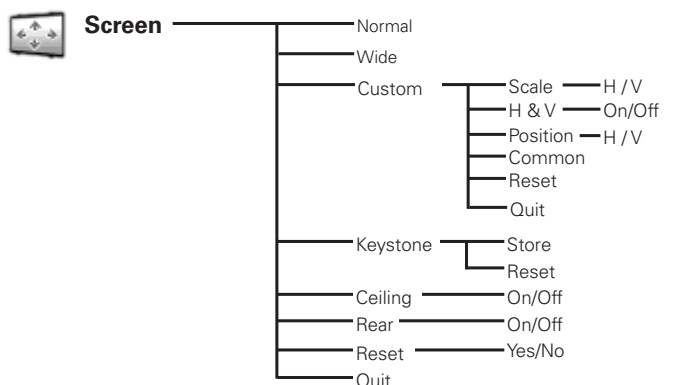
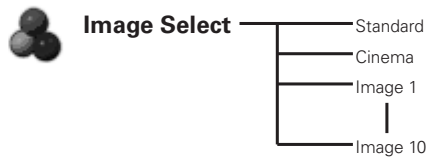
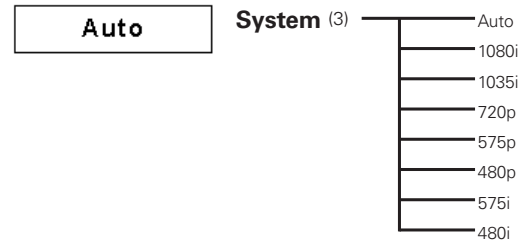
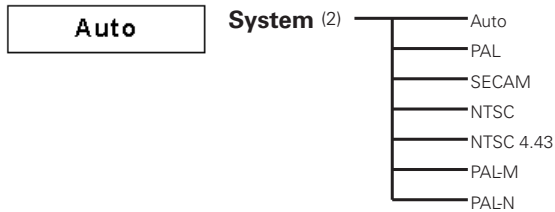

✓ **Note:**

•The Menu display varies depending on the input signal.



## Computer Input/Video Input



### Setting

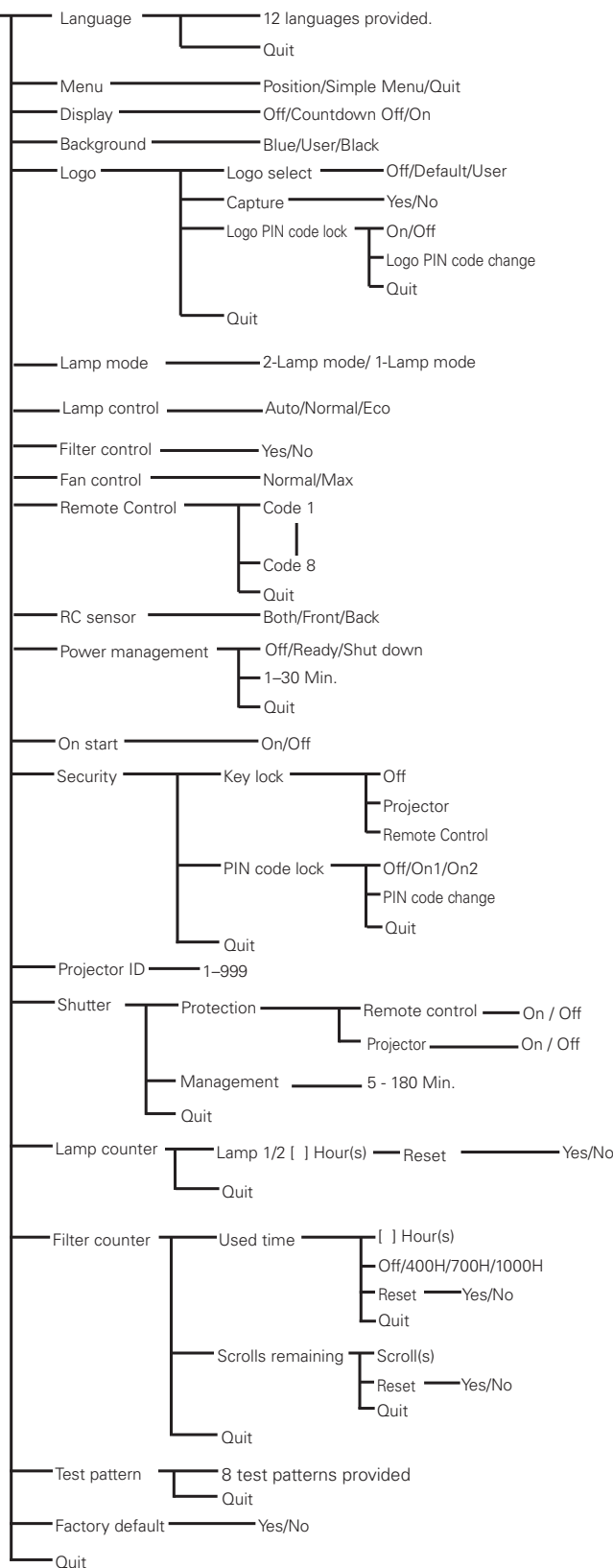

## Indicators and Projector Condition

Check the indicators for the projector condition.

The projector is operating normally.

| Indicators  |                |                         |                             |                 |                            | Projector Condition   |
|-------------|----------------|-------------------------|-----------------------------|-----------------|----------------------------|---|
| LAMP<br>red | READY<br>green | WARNING<br>TEMP.<br>red | WARNING<br>FILTER<br>orange | SHUTTER<br>blue | LAMP 1/2<br>REP.<br>orange |   |
| ●           | ●              | ●                       | ●                           | ●               | ●                          | The projector is off. (The main On/Off switch is OFF position or the AC power cord is unplugged.)   |
| ○           | ○              | ●                       | *                           | *               | *                          | The projector is in stand-by mode. Press the ON/STAND-BY button to turn on the projector.   |
| ●           | ○              | ●                       | *                           | ●               | *                          | The projector is operating normally. (The Shutter is open)  |
| ●           | ○              | ●                       | *                           | ○               | *                          | The projector is operating normally. (The Shutter is closed)  |
| ○           | ●              | ●                       | *                           | *               | *                          | The projector is preparing for stand-by or the projection lamp is being cooled down. The projector cannot be turned on until cooling is completed and the READY indicator lights green.   |
| ●           | ●              | ●                       | *                           | ●               | *                          | The projection lamp is being cooled down in the Power management mode.  |
| ●           | ⊙              | ●                       | *                           | ●               | *                          | The projector is in the Power management mode.  |
| ●           | ●              | ●                       | *                           | ⊙               | *                          | The projection lamp is being cooled down in the Shutter management mode.  |
| ●           | ○              | ●                       | *                           | ⊙               | *                          | The projector is in the Shutter management mode. Press the ON/STAND-BY button to turn on the projector.   |
| ●           | ○              | ●                       | ⊙                           | *               | *                          | The filter is scrolled using the FILTER button on the remote control or the Filter control function in the setting menu. When the filter is being scrolled, the Filter replacement icon and "Please wait..." message (Fig. 1) appear on the screen. |



Please wait . . .

Fig.1 Filter replacement icon and "Please wait..."

○ ●●● on

● ●●● dim

● ●●● off

⊙ ●●● blinking at the normal rate  
(approx. 1 second ON,  
1 second OFF)

⊙ ●●● blinking fast  
(approx. 0.5 seconds ON,  
0.5 seconds OFF)

⊙ ●●● blinking slow  
(approx. 2 seconds ON,  
2 seconds OFF)

\* ●●● Differs according to conditions.

The projector is detecting abnormal condition.

| Indicators |             |                   |                       |              |                      | Projector Condition  |
|------------|-------------|-------------------|-----------------------|--------------|----------------------|--|
| LAMP red   | READY green | WARNING TEMP. red | WARNING FILTER orange | SHUTTER blue | LAMP 1/2 REP. orange |  |
|            |             |                   | *                     | *            | *                    | The temperature inside the projector is elevated close to the abnormally high level.   |
|            |             |                   | *                     | *            | *                    | The temperature inside the projector is abnormally high. The projector cannot be turned on. When the projector is cooled down enough and the temperature returns to normal, the READY indicator lights green and the projector can be turned on. (The WARNING TEMP. indicator keeps blinking.) |
|            |             |                   | *                     | *            | *                    | The projector has been cooled down enough and the temperature returns to normal. When turning on the projector, the WARNING TEMP. indicator stops blinking. Check and replace the filter.  |
|            |             |                   | *                     | *            |                      | The lamp cannot light up. (The projector is preparing for stand-by or the projection lamp is being cooled down. The projector cannot be turned on until cooling is completed.)   |
|            |             |                   | *                     | *            |                      | The lamp cannot light up. (The lamp has been cooled down enough and the projector is in stand-by mode and ready to be turned on with the ON/STAND-BY button.)  |
|            |             | *                 | *                     | *            |                      | When either of the 2 lamps is out, the projector operates with 1 lamp.   |
| *          | *           | *                 | *                     | *            |                      | The lamp has been used overtime. Replace the lamp immediately and then reset the lamp counter. The indicator will be turned off after resetting the counter.   |

**WARNING FILTER**

When the filter detects clogging, reaches a time set in the timer setting or runs out of the filter scroll, the WARNING FILTER indicator lights orange. When this indicator lights orange, replace the filter or the filter cartridge with a new one promptly. Reset the Filter counter and Scroll counter after replacing the filter cartridge (p.59).

**LAMP REPLACE 1 and 2**

When the LAMP 1 REPLACE indicator and the LAMP 2 REPLACE indicator light orange, replace the projection lamps with new ones promptly. And then reset the Lamp time after replacement of the lamps. See pages 55, 61, and 62.

The projector is detecting abnormal condition.

| Indicators   |                |                         |                             |                 |                            | Projector Condition  |
|--|----------------|-------------------------|-----------------------------|-----------------|----------------------------|--|
| LAMP<br>red  | READY<br>green | WARNING<br>TEMP.<br>red | WARNING<br>FILTER<br>orange | SHUTTER<br>blue | LAMP 1/2<br>REP.<br>orange |  |
|  |                |                         |                             |                 |                            | <p>If the Filter counter reached a time set in the timer setting, a Filter replacement icon (Fig.2) appears on the screen and the WARNING FILTER indicator on the top panel lights up. Replace the filter as soon as possible. If the filter is out of scroll and the projector reaches a time set in the timer setting, Fig. 3 appears on the screen and the WARNING FILTER indicator lights up. Replace the filter cartridge as soon as possible.</p> <p>If the filter is clogged and no scroll is left in the filter cartridge, a Filter cartridge replacement icon (Fig.4) appears on the screen and the WARNING FILTER indicator lights up. Replace the filter cartridge as soon as possible.</p> <p><b>✓ Note:</b><br/>•Fig.2, Fig.3 and Fig.4 icon will not appear when the Display function is set to "Off" (p.48), or during "Freeze" (p.29).</p> |
| <br><b>Fig.2</b> Filter replacement icon<br><br><br><b>Fig.3</b><br><br><br><b>Fig.4</b> Filter cartridge replacement icon |                |                         |                             |                 |                            |  |
|  |                |                         |                             |                 |                            | The projector detects an abnormal condition during filter scroll.  |
|  |                |                         |                             |                 |                            | The projector is being cooled down after detecting an abnormal condition during filter scroll.   |
|  |                |                         |                             |                 |                            | The projector has been cooled down enough and is in the stand-by mode after detecting an abnormal condition during filter scroll.  |
|  |                |                         |                             |                 |                            | <p>The filter cartridge is not installed in the projector. Check the filter compartment to see if the filter cartridge is installed in the projector. When the filter cartridge is installed and the indicators continue to light and blink, read the column below.</p> <p>The projector detects an abnormal condition and cannot be turned on. Unplug the AC power cord and plug it again to turn on the projector. If the projector is turned off again, unplug the AC power cord and contact the dealer or the service center. Do not leave the projector on. It may cause an electric shock or a fire hazard.</p>  |
|  |                |                         |                             |                 |                            | The shutter is out of control.   |
|  |                |                         |                             |                 |                            | The shutter is out of control. (The projector is in the cooling mode.)   |
|  |                |                         |                             |                 |                            | The shutter is out of control. (The projector is in the stand-by mode.) In that case, contact the service center immediately.  |

### Compatible Computer Specifications

Basically this projector can accept the signal from all computers with the V- and H-Frequency mentioned below and less than 230 MHz of Dot Clock.

▭ PC Adjustment can be limited when these modes are selected.

| ON-SCREEN DISPLAY | RESOLUTION           | H-Freq.(kHz) | V-Freq.(Hz) |
|-------------------|----------------------|--------------|-------------|
| VGA 1             | 640x480              | 31.470       | 59.880      |
| VGA 2             | 720x400              | 31.470       | 70.090      |
| VGA 3             | 640x400              | 31.470       | 70.090      |
| VGA 4             | 640x480              | 37.860       | 74.380      |
| VGA 5             | 640x480              | 37.860       | 72.810      |
| VGA 6             | 640x480              | 37.500       | 75.000      |
| VGA 7             | 640x480              | 43.269       | 85.000      |
| MAC LC13          | 640x480              | 34.970       | 66.600      |
| MAC 13            | 640x480              | 35.000       | 66.670      |
| 480p              | 640x480              | 31.470       | 59.880      |
| 575p              | 768x575              | 31.250       | 50.000      |
| 575i              | 768x576 (Interlace)  | 15.625       | 50.000      |
| 480i              | 640x480 (Interlace)  | 15.734       | 60.000      |
| SVGA 1            | 800x600              | 35.156       | 56.250      |
| SVGA 2            | 800x600              | 37.880       | 60.320      |
| SVGA 3            | 800x600              | 46.875       | 75.000      |
| SVGA 4            | 800x600              | 53.674       | 85.060      |
| SVGA 5            | 800x600              | 48.080       | 72.190      |
| SVGA 6            | 800x600              | 37.900       | 61.030      |
| SVGA 7            | 800x600              | 34.500       | 55.380      |
| SVGA 8            | 800x600              | 38.000       | 60.510      |
| SVGA 9            | 800x600              | 38.600       | 60.310      |
| SVGA 10           | 800x600              | 32.700       | 51.090      |
| SVGA 11           | 800x600              | 38.000       | 60.510      |
| MAC 16            | 832x624              | 49.720       | 74.550      |
| XGA 1             | 1024x768             | 48.360       | 60.000      |
| XGA 2             | 1024x768             | 68.677       | 84.997      |
| XGA 3             | 1024x768             | 60.023       | 75.030      |
| XGA 4             | 1024x768             | 56.476       | 70.070      |
| XGA 5             | 1024x768             | 60.310       | 74.920      |
| XGA 6             | 1024x768             | 48.500       | 60.020      |
| XGA 7             | 1024x768             | 44.000       | 54.580      |
| XGA 8             | 1024x768             | 63.480       | 79.350      |
| XGA 9             | 1024x768 (Interlace) | 36.000       | 87.170      |
| XGA 10            | 1024x768             | 62.040       | 77.070      |
| XGA 11            | 1024x768             | 61.000       | 75.700      |
| XGA 12            | 1024x768 (Interlace) | 35.522       | 86.960      |
| XGA 13            | 1024x768             | 46.900       | 58.200      |
| XGA 14            | 1024x768             | 47.000       | 58.300      |
| XGA 15            | 1024x768             | 58.030       | 72.000      |
| MAC 19            | 1024x768             | 60.240       | 75.080      |
| SXGA 1            | 1152x864             | 64.200       | 70.400      |
| SXGA 2            | 1280x1024            | 62.500       | 58.600      |
| SXGA 3            | 1280x1024            | 63.900       | 60.000      |
| SXGA 4            | 1280x1024            | 63.340       | 59.980      |
| SXGA 5            | 1280x1024            | 63.740       | 60.010      |

| ON-SCREEN DISPLAY | RESOLUTION            | H-Freq.(kHz) | V-Freq.(Hz) |
|-------------------|-----------------------|--------------|-------------|
| SXGA 6            | 1280x1024             | 71.690       | 67.190      |
| SXGA 7            | 1280x1024             | 81.130       | 76.107      |
| SXGA 8            | 1280x1024             | 63.980       | 60.020      |
| SXGA 9            | 1280x1024             | 79.976       | 75.025      |
| SXGA 10           | 1280x960              | 60.000       | 60.000      |
| SXGA 11           | 1152x900              | 61.200       | 65.200      |
| SXGA 12           | 1152x900              | 71.400       | 75.600      |
| SXGA 13           | 1280x1024 (Interlace) | 50.000       | 86.000      |
| SXGA 14           | 1280x1024 (Interlace) | 50.000       | 94.000      |
| SXGA 15           | 1280x1024             | 63.370       | 60.010      |
| SXGA 16           | 1280x1024             | 76.970       | 72.000      |
| SXGA 17           | 1152x900              | 61.850       | 66.000      |
| SXGA 18           | 1280x1024 (Interlace) | 46.430       | 86.700      |
| SXGA 19           | 1280x1024             | 63.790       | 60.180      |
| SXGA 20           | 1280x1024             | 91.146       | 85.024      |
| SXGA+ 1           | 1400x1050             | 63.970       | 60.190      |
| SXGA+ 2           | 1400x1050             | 65.350       | 60.120      |
| SXGA+ 3           | 1400x1050             | 65.120       | 59.900      |
| SXGA+ 4           | 1400x1050             | 64.030       | 60.010      |
| SXGA+ 5           | 1400x1050             | 62.500       | 58.600      |
| MAC 21            | 1152x870              | 68.680       | 75.060      |
| MAC               | 1280x960              | 75.000       | 75.080      |
| MAC               | 1280x1024             | 80.000       | 75.080      |
| WXGA 1            | 1366x768              | 48.360       | 60.000      |
| WXGA 2            | 1360x768              | 47.700       | 60.000      |
| WXGA 3            | 1376x768              | 48.360       | 60.000      |
| WXGA 4            | 1360x768              | 56.160       | 72.000      |
| WXGA 6            | 1280x768              | 47.776       | 59.870      |
| WXGA 7            | 1280x768              | 60.289       | 74.893      |
| WXGA 8            | 1280x768              | 68.633       | 84.837      |
| WXGA 9            | 1280x800              | 49.600       | 60.050      |
| WXGA 10           | 1280x800              | 41.200       | 50.000      |
| WXGA 11           | 1280x800              | 49.702       | 59.810      |
| WXGA 12           | 1280x800              | 63.980       | 60.020      |
| WUXGA 1           | 1920x1200             | 74.556       | 59.885      |
| WSXGA+ 1          | 1680x1050             | 65.290       | 59.954      |
| WXGA+ 1           | 1440x900              | 55.935       | 59.887      |
| UXGA 1            | 1600x1200             | 75.000       | 60.000      |
| UXGA 2            | 1600x1200             | 81.250       | 65.000      |
| UXGA 3            | 1600x1200             | 87.500       | 70.000      |
| UXGA 4            | 1600x1200             | 93.750       | 75.000      |
| UXGA 5            | 1600x1200             | 106.250      | 85.000      |
| 720p              | 1280x720              | 45.000       | 60.000      |
| 720p              | 1280x720              | 37.500       | 50.000      |
| 1035i             | 1920x1035 (Interlace) | 33.750       | 60.000      |
| 1080i             | 1920x1080 (Interlace) | 33.750       | 60.000      |
|                   | 1920x1080 (Interlace) | 28.125       | 50.000      |

\*

“True” cannot be selected when WUXGA1, UXGA2, UXGA3, UXGA4 and UXGA5 are selected (p.39)

When an input signal is digital from the DVI terminal, refer to the chart below.

| ON-SCREEN DISPLAY | RESOLUTION | H-Freq.(kHz) | V-Freq.(Hz) |
|-------------------|------------|--------------|-------------|
| D-VGA             | 640x480    | 31.470       | 59.940      |
| D-480p            | 720x480    | 31.470       | 59.880      |
| D-575p            | 720x575    | 31.250       | 50.000      |
| D-SVGA            | 800x600    | 37.879       | 60.320      |
| D-XGA             | 1024x768   | 43.363       | 60.000      |
| D-WXGA 1          | 1366x768   | 48.360       | 60.000      |
| D-WXGA 2          | 1360x768   | 47.700       | 60.000      |
| D-WXGA 3          | 1376x768   | 48.360       | 60.000      |
| D-WXGA 4          | 1360x768   | 56.160       | 72.000      |
| D-WXGA 5          | 1366x768   | 46.500       | 50.000      |
| D-WXGA 6          | 1280x768   | 47.776       | 59.870      |
| D-WXGA 7          | 1280x768   | 60.289       | 74.893      |
| D-WXGA 8          | 1280x768   | 68.633       | 84.837      |
| D-WXGA 9          | 1280x800   | 49.600       | 60.050      |
| D-WXGA 10         | 1280x800   | 41.200       | 50.000      |
| D-WXGA 11         | 1280x800   | 49.702       | 59.810      |
| D-WXGA 12         | 1280x800   | 63.980       | 60.020      |
| D-SXGA 1          | 1280x1024  | 63.980       | 60.020      |
| D-SXGA 2          | 1280x1024  | 60.276       | 58.069      |

| ON-SCREEN DISPLAY | RESOLUTION               | H-Freq.(kHz) | V-Freq.(Hz) |
|-------------------|--------------------------|--------------|-------------|
| D-SXGA+ 1         | 1400x1050                | 63.970       | 60.190      |
| D-SXGA+ 2         | 1400x1050                | 65.350       | 60.120      |
| D-SXGA+ 3         | 1400x1050                | 65.120       | 59.900      |
| D-WSXGA+ 1        | 1680x1050                | 65.290       | 59.954      |
| D-WXGA+ 1         | 1440x900                 | 55.935       | 59.887      |
| D-720p            | 1280x720                 | 45.000       | 60.000      |
| D-720p            | 1280x720                 | 37.500       | 50.000      |
| D-1035i           | 1920x1035<br>(Interlace) | 33.750       | 60.000      |
| D-1080i           | 1920x1080<br>(Interlace) | 33.750       | 60.000      |
|                   | 1920x1080<br>(Interlace) | 28.125       | 50.000      |
| D-1080psf/30      | 1920x1080                | 33.750       | 60.000      |
| D-1080psf/25      | 1920x1080                | 28.125       | 50.000      |
| D-1080psf/24      | 1920x1080                | 27.000       | 48.000      |

✓ **Note:**

- Depending on the condition of signals and the type and length of cables, these signals may not be properly viewed.
- Specifications are subject to change without notice.

## Technical Specifications

### Mechanical Information

|                        |  |
|------------------------|--|
| Projector Type         | Multi-media Projector                                    |
| Dimensions (W x H x D) | 20.87" x 10.55" x 29.8" (530.0 mm x 268.0 mm x 757.0 mm) |
| Net Weight             | 60.85lbs (27.6 kg)                                       |
| Feet Adjustment        | 0° to 2.8°   |

### Panel Resolution

|                  |                                       |
|------------------|---------------------------------------|
| LCD Panel System | 1.8" TFT Active Matrix type, 3 panels |
| Panel Resolution | 1,024 x 768 dots                      |
| Number of Pixels | 2,359,296 (1,024 x 768 x 3 panels)    |

### Signal Compatibility

|                    |  |
|--------------------|--|
| Color System       | PAL, SECAM, NTSC, NTSC4.43, PAL-M, and PAL-N   |
| SD/HDTV Signal     | 480i, 480p, 575i, 575p, 720p, 1035i, and 1080i |
| Scanning Frequency | H-sync. 15 kHz–120 kHz, V-sync. 48 Hz–120 Hz   |

### Optical Information

|                 |                     |
|-----------------|---------------------|
| Projection Lamp | 330 W NSHA lamp x 2 |
|-----------------|---------------------|

### Interface

|             |  |
|-------------|--|
| Input 1     | DVI-D Terminal (Digital), Mini D-Sub 15-pin Terminal (Analog)                        |
| Input 2     | BNC Type x 5 (VIDEO/Y/G, B/Pb/Cb, R/Pr/Cr, H/HV and V), S-Video                      |
| Other Jacks | Serial port in (D-sub 9), Serial port out (D-sub 9), USB port, and Wired Remote Jack |

### Power

|                               |  |
|-------------------------------|--|
| Voltage and Power Consumption | AC 100–120 V (11.2A Max. Ampere), 50/60 Hz (The U.S.A and Canada)<br>AC 200-240 V (5.1A Max. Ampere), 50/60 Hz (Continental Europe and The U.K.) |
|-------------------------------|--|

### Operating Environment

|                       |                         |
|-----------------------|-------------------------|
| Operating Temperature | 41°F–104°F (5°C–40°C)   |
| Storage Temperature   | 14°F–140°F (-10°C–60°C) |

### Remote Control

|                 |  |
|-----------------|--|
| Battery         | AA or LR6 Type x 2   |
| Operating Range | 16.4' (5 m/±30°)   |
| Dimensions      | 1.79" (W) x 1.03" (H) x 6.24" (D) (45.5 mm x 26.2 mm x 158.5 mm) |
| Net Weight      | 4.1 oz (117 g) (including batteries)                             |

### Accessories

|  |
|--|
| User's Manual (CD-ROM)                         |
| Quick Reference Guide                          |
| AC Power Cord                                  |
| Remote Control and Batteries                   |
| VGA Cable                                      |
| PIN Code Label                                 |
| Lens Attachments (2 types) (For option lens)   |
| Light Block Plates (3 types) (For option lens) |
| Spacer (For option lens)                       |
| Real Color Manager Pro (CD-ROM)                |
| Mounting Clamp                                 |
| Strap (For lens mount cover)                   |

- The specifications are subject to change without notice.
- LCD panels are manufactured to the highest possible standards. Even though 99.99% of the pixels are effective, a tiny fraction of the pixels (0.01% or less) may be ineffective by the characteristics of the LCD panels.
- Each projector has its own characteristics.  
When projecting with several projectors on the same screen or side by side, you may recognize different white balance and color uniformity on each projector.

## Optional Parts

The parts listed below are optionally available. When ordering those parts, specify the item name and Model No. to the sales dealer.

|  | <i>Model No.</i> |
|--|------------------|
| <b>Option Slot Board (DVI/D-sub 15)</b>  | : 103-134109-02  |
| <b>Option Slot Board (5-BNC/VIDEO)</b>   | : 103-133108-02  |
| <b>Option Slot Board (Dual-SDI)</b>      | : 103-132107-02  |
| <b>Option Slot Board (Network board)</b> | : 103-144100-01  |



## Configurations of Terminals

### ANALOG (Mini D-sub 15 pin)

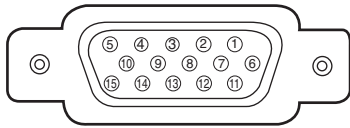

|   |                      |    |                      |
|---|----------------------|----|----------------------|
| 1 | Red Input            | 9  | +5V Power            |
| 2 | Green Input          | 10 | Ground (Vert. sync.) |
| 3 | Blue Input           | 11 | Ground               |
| 4 | No Connect           | 12 | DDC Data             |
| 5 | Ground (Horiz.sync.) | 13 | Horiz. sync.         |
| 6 | Ground (Red)         | 14 | Vert. sync.          |
| 7 | Ground (Green)       | 15 | DDC Clock            |
| 8 | Ground (Blue)        |    |                      |

### DIGITAL DVI-D (DVI 24 PIN)

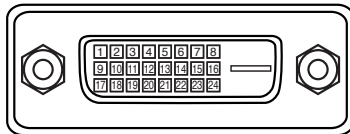

|   |                       |    |                       |    |                       |
|---|-----------------------|----|-----------------------|----|-----------------------|
| 1 | T.M.D.S. Data2-       | 9  | T.M.D.S. Data1-       | 17 | T.M.D.S. Data0-       |
| 2 | T.M.D.S. Data2+       | 10 | T.M.D.S. Data1+       | 18 | T.M.D.S. Data0+       |
| 3 | T.M.D.S. Data2 Shield | 11 | T.M.D.S. Data1 Shield | 19 | T.M.D.S. Data0 Shield |
| 4 | No Connect            | 12 | No Connect            | 20 | No Connect            |
| 5 | No Connect            | 13 | No Connect            | 21 | No Connect            |
| 6 | DDC Clock             | 14 | +5V Power             | 22 | T.M.D.S. Clock Shield |
| 7 | DDC Data              | 15 | Ground (for +5V)      | 23 | T.M.D.S. Clock+       |
| 8 | No Connect            | 16 | Hot Plug Detect       | 24 | T.M.D.S. Clock-       |

### USB CONNECTOR (Series B)

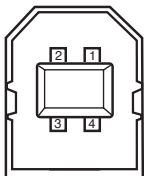

|   |        |
|---|--------|
| 1 | Vcc    |
| 2 | - Data |
| 3 | + Data |
| 4 | Ground |

### CONTROL PORT CONNECTOR (D-sub 9 pin)

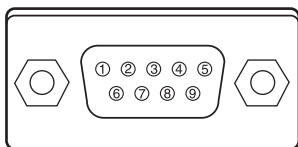

|   | Serial     |
|---|------------|
| 1 | No Connect |
| 2 | R X D      |
| 3 | T X D      |
| 4 | No Connect |
| 5 | SG         |
| 6 | No Connect |
| 7 | No Connect |
| 8 | No Connect |
| 9 | No Connect |

### ***PIN Code Number Memo***

Write down the PIN code number in the column below and keep it with this manual securely. If you forgot or lost the number and unable to operate the projector, contact the service center.

|                                      |   |  |  |  |  |
|--------------------------------------|---|--|--|--|--|
| <b><i>PIN Code Lock No.</i></b>      | <table border="1" style="width: 100%; height: 30px;"> <tr> <td style="width: 25%;"></td> <td style="width: 25%;"></td> <td style="width: 25%;"></td> <td style="width: 25%;"></td> </tr> </table> |  |  |  |  |
|                                      |   |  |  |  |  |
|                                      | <b><i>Factory default set No: 1 2 3 4*</i></b>  |  |  |  |  |
| <b><i>Logo PIN Code Lock No.</i></b> | <table border="1" style="width: 100%; height: 30px;"> <tr> <td style="width: 25%;"></td> <td style="width: 25%;"></td> <td style="width: 25%;"></td> <td style="width: 25%;"></td> </tr> </table> |  |  |  |  |
|                                      |   |  |  |  |  |
|                                      | <b><i>Factory default set No: 4 3 2 1*</i></b>  |  |  |  |  |
|                                      | *Should the four-digit number be changed, the factory set number will be invalid.   |  |  |  |  |

While the projector is locked with the PIN code...

Put the label below (supplied) on in a prominent place of the projector's body while it is locked with a PIN code.

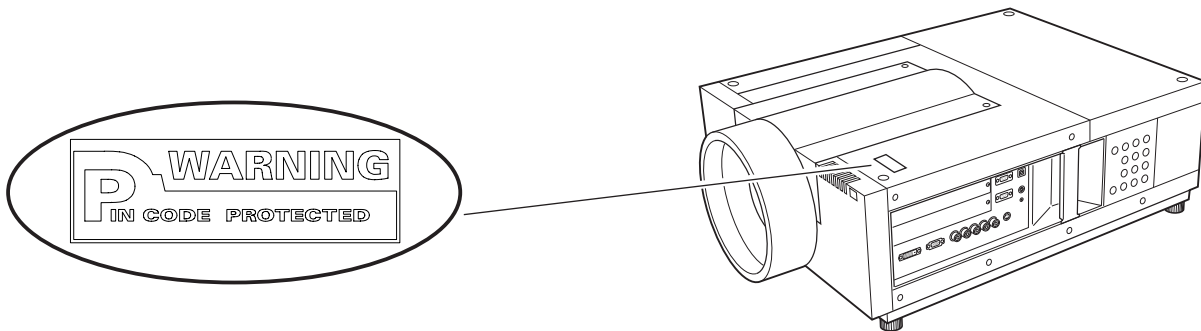

**Dimensions**

Unit: inch (mm)

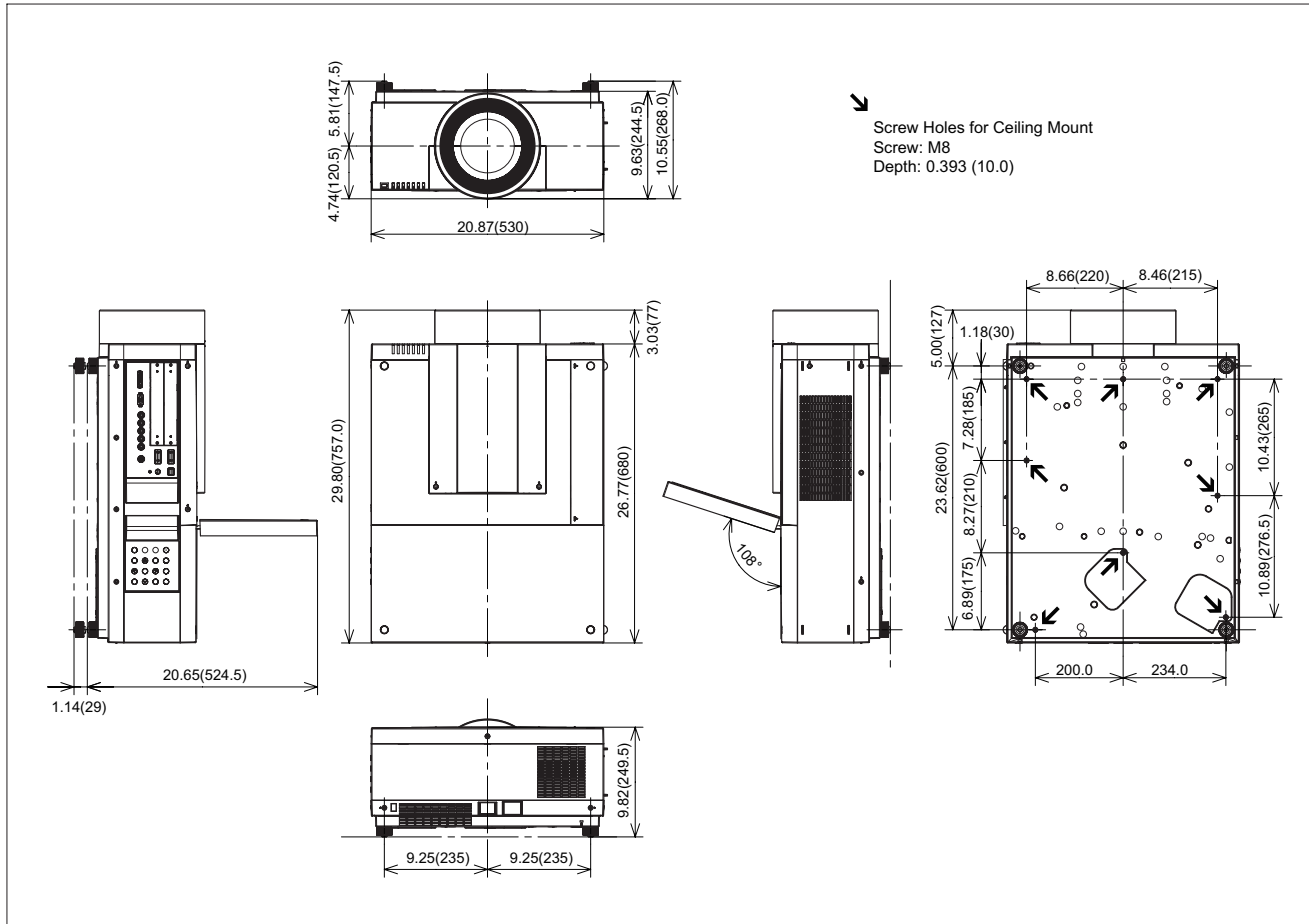

# CHRISTIE®

## Americas

### USA

**Christie Digital Systems USA, Inc.**  
10550 Camden Drive  
Cypress CA 90630  
PH: 714-236-8610  
FX: 714-503-3375  
Customer Service: 1-866-880-4462  
sales-us@christiedigital.com

### Canada

**Christie Digital Systems Canada, Inc.**  
809 Wellington St. N.  
Kitchener, Ontario N2G 4Y7  
PH: 519-744-8005  
FX: 519-749-3321  
Customer Service: 1-800-265-2171  
sales-canada@christiedigital.com

### Chile

**Representative Office  
Christie Digital Systems USA, Inc.**  
Av. Pedro Fontova 7619 of 60  
Santiago  
PH: 56-2-721 11 75  
Mobile: 5699 436 6555

## Europe, Middle East & Africa

### United Kingdom

**Branch Office  
Christie Digital Systems Canada, Inc.**  
ViewPoint  
200 Ashville Way  
Wokingham  
Berkshire, U.K.  
RG41 2PL  
PH: +44 (0) 118 977 8000  
FX: +44 (0) 118 977 8100  
sales-europe@christiedigital.com

### France

**Representative Office  
Christie Digital Systems Canada, Inc.**  
Bâtiment D-Hall 4  
Parc Louis Roche  
96/114 Avenue Louis Roche  
F-92230 Gennevilliers  
France  
PH: +33 (0)1 41 21 44 04  
FX: +33 (0)1 41 21 00 36  
sales-france@christiedigital.com

### Germany

**Representative Office  
Christie Digital Systems Canada, Inc.**  
Willicher Damm 129  
D-41066  
Mönchengladbach  
PH: +49 2161 664540  
FX: +49 2161 664546  
sales-germany@christiedigital.com

### Eastern Europe

**Representative Office  
Christie Digital Systems Canada, Inc.**  
Regus Bank Centre  
Szabadsag ter 7.  
H-1054 Budapest  
Hungary  
PH: +36 (0)1 47 48 100  
FX: +36 (0)1 47 48 452  
sales-europe@christiedigital.com

### Middle East

**Representative Office  
Christie Digital Systems Canada, Inc.**  
C/O Emirates Group Security  
Building,  
C Block, Room 207, 208, 209  
Airport Free Zone  
PO Box 293762  
Dubai, UAE  
PH: +971 (0) 4 299 7575  
FX: +971 (0) 4 299 8077

### Spain

**Christie Authorized Reseller**  
Antonio Abad  
Polígono Industrial Ventorro Del  
Cano  
Esquina C/ Aldea del Fresno, 3  
3ª Puerta. Izqda  
28925 Alcorcón, Madrid  
PH: + 34 91 633 9990  
FX: + 34 91 633 9991

### Italy

**Christie Authorized Reseller**  
Angelo Tacca  
Via Garibaldi, 88  
20024 Garbagnate Milanese (MI)  
PH: +39 02 9902 1161  
FX: +39 02 9902 2641

### Africa

**Representative Office  
Christie Digital Systems Canada, Inc.**  
4 Patricia Road  
Gillitts  
KwaZulu Natal  
3610  
Republic of South Africa  
PH: +27 (0) 317 671 347  
FX: +27 (0) 317 671 347  
MB: +27 (0) 823 045 442

## Asia Pacific

### Singapore

**Branch Office  
Christie Digital Systems USA, Inc.**  
627A Aljunied Road  
# 05-02 Biz Tech Centre  
Singapore, 389842  
PH: +65 6877-8737  
FX: +65 6877-8747  
sales-singapore@christiedigital.com

### China - Beijing

**Representative Office  
Christie Digital Systems USA, Inc.**  
7B15, Hanwei Plaza  
Guanghua Road  
Chaoyang District,  
Beijing, 100004  
PH: +86 10 6561 0240  
FX: +86 10 6561 0546  
sales-china@christiedigital.com

### China - Shanghai

**Representative Office  
Christie Digital Systems USA, Inc.**  
Room 1109-1116 Shartex Plaza  
No. 88 Zun Yi South Road  
Shanghai 200336  
PH: +86 21 6278 7708  
FX: +86 21 6278 5816  
sales-china@christiedigital.com

### Japan

**Representative Office  
Christie Digital Systems USA, Inc.**  
A-bldg., 2nd Floor  
Ariake Frontier Building  
3-1-25, Ariake, Koto-ku  
Tokyo, 135-0063  
PH: 81-3-3599-7481  
FX: 81-3-3599-7482  
sales-japan@christiedigital.com

### South Korea

**Representative Office  
Christie Digital Systems USA, Inc.**  
6F, ILSIN Building, 15-15  
Yeouido-dong,  
Yeongdeungpo-gu, Seoul,  
150-872 South Korea  
PH: +82 2 702 1601  
FX: +82 2 702 1602

### India

**Representative Office  
Christie Digital Systems USA, Inc.**  
Unit No. 03, Navigator Building  
International Technology Park  
Whitefield Road  
Bangalore 560 066  
India  
PH: (080) 41468941 – 48  
FX: (080) 41468949

[www.christiedigital.com](http://www.christiedigital.com)



#### Corporate offices

USA – Cypress  
ph: 714-236-8610  
Canada – Kitchener  
ph: 519-744-8005

#### Worldwide offices

United Kingdom  
ph: +44 118 977 8000  
France  
ph: +33 (0) 1 41 21 00 36  
Germany  
ph: +49 2161 664540

Eastern Europe  
ph: +36 (0) 1 47 48 100  
Middle East  
ph: +971 (0) 4 299 7575  
Spain  
ph: + 34 91 633 9990

Singapore  
ph: +65 6877-8737  
Beijing  
ph: +86 10 6561 0240  
Shanghai  
ph: +86 21 6278 7708

Japan  
ph: 81-3-3599-7481  
South Korea  
ph: +82 2 702 1601

